



Government of Nepal  
National Reconstruction Authority

# Guidelines for Extension of Masonry Buildings

For Houses that have Been Built During Earthquake  
Housing Reconstruction Programme



Government of Nepal  
**National Reconstruction Authority (NRA)**  
June 2021

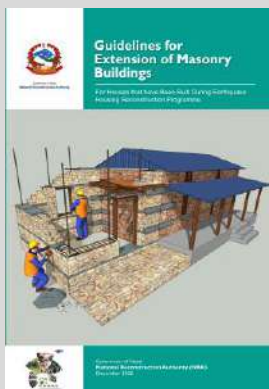

## **GUIDELINES FOR EXTENSION OF MASONRY BUILDINGS**

for houses that have been built during Earthquake Housing Reconstruction Programme

Copyright © NRA 2021

### **Published by**

Government of Nepal  
National Reconstruction Authority (NRA)  
Singh Durbar, Kathmandu, Nepal  
Tel: (977-01) 4211482, 4211467,  
Fax: 4211473  
Email: [info@nra.gov.np](mailto:info@nra.gov.np),  
Web: [nra.gov.np](http://nra.gov.np)

### **Graphics/Layout**

Chandan Dhoj Rana Magar,  
Web/Graphics Designer, NSET

### **First Edition**

June 2021

### **Printed Copy:**

500 pcs



Government of Nepal  
National Reconstruction Authority

# Guidelines for Extension of Masonry Buildings

for houses that have been built under  
Housing Reconstruction Programme

Government of Nepal  
**National Reconstruction Authority (NRA)**  
June 2021

This Page is Intentionally Left Blank

## Foreword

We have been receiving reassurances that the NRA's owner driven approach has created built in dynamo for accelerating housing reconstruction while maintaining construction quality. The NRA deployed more than 3000 engineers and social mobilisers at the grass root level for the first time in Nepal's history which has left its footprints not only in the form of reconstructed houses but also for embedding earthquake resilient technology at the local level. NRA ensured compliance through three tranches system of housing grant by ensuring adherence of building code in each crucial stage.



At present, 92% of about 850,000 beneficiary houses have been reconstructed across the 32 districts. There are certain issues of vulnerable households and urban housing reconstruction which we are grappling through appropriate policy intervention.

With this publication, we intend to ensure future extension also complying with the building codes. We are fully confident that the local governments, who are formally trusted to handle the promotion and sustenance of the housing stocks in the county, will leave no stone unturned towards that objective. They will find this publication instrumental for carrying forward their responsibility.

We are confident that the Government of Nepal (GoN) will propagate the earthquake resilient technology to all 77 districts of Nepal. There are certain conceptual, technological and procedural elements which can be replicated in other countries as well particularly where our socio-economic situations are identical.

This is one of the publications of the International Conference on Nepal's Reconstruction (ICNR-2021). We have been recording NRA's experience holistically and present to the national and international audience. Hope all communities vulnerable to earthquake will benefit out of these ICNR publications.

### Sushil Gyewali

Chief Executive Officer  
National Reconstruction Authority

## Acknowledgements

We would like to express our gratitude to the team of professionals for their contribution, guidance and quality assurance. Mr. Shyam Kishor Singh, Mr. Jhapper Singh Vishokarma, Mr. Surya Narayan Shrestha, Dr Ramesh Guragain, Mr. Bipin Gautam, Ms. Hima Shrestha, and Ms. Rajani Prajapati contributed on the conceptual discourse and on the critical issues.



Acknowledgements are due to the commentators on the draft report: Dr Hariram Parajuli, Mr. Jitendra Bothara and Mr. Vivek Rawal. Their highly professional inputs enhanced its implementability. In addition, ICNR Secretariat including Dr Chandra Bahadur Shrestha, Convenor; Mr. Manohar Ghimire, Member Secretary and Mr. Sandeep Gurung, Junior Conference Expert facilitated the entire process.

Mr. Ranjan Dhungel, Mr. Aasish Tiwari, Mr. Ayush Baskota, Ms. Parbati Motra, Mr. Manish Raj Gouli, Ms. Geeta Bhandari and Mr. Chandan Dhoj Rana Magar deserve our heartfelt appreciation for their contribution to draft this document. Only through their tireless efforts, this document saw the day light.

In addition, we extend our sincere appreciation to USAID for their support to Baliyo Ghar Program implemented by NSET through which this guideline is published. We borrowed substantial body of knowledge on house extension using buttresses from UNDP's document entitled 'How to extend your house safely, A Guide for Extending your House at the Ground Floor' which were co-authored by Mr. Vivek Rawal and Mr. Jnananjan Panda.

NRA organised a workshop where hundreds of participants from various governmental, non-governmental, donors and academicians contributed for the enrichment of this document. We are grateful to all of them. Last but not the least we would like to extend our sincere thanks to all individuals who contributed explicitly or implicitly.

### Sushil Chandra Tiwari

Secretary  
National Reconstruction Authority

## Preface

NRA intended to contribute towards the creation of earthquake resilient society through “Build Back Better” principle. In retrospection, we are pleased to see that we could inject the earthquake resilient technology in 32 districts of Nepal. The technological spill over effect to other districts has been taking place through the masons who were engaged in the reconstruction of private and public buildings.



NRA was created for five years stint under the sunset law with provision of one year extension. Within that time constraint, NRA formulated policies with some premises that the earthquake victims will reconstruct their house according to their requirement within the stipulated deadline. However, having limited financial resources, dearth of construction workers and other unexplained family reasons, beneficiaries constructed their core houses which enabled them to access NRA grants. However, as they garnered adequate resources, availability of construction workers resumed, and their migrant family member returned to their house the beneficiaries kicked off vertical and horizontal extension.

It is important that such extensions must have to comply with the building code which ensures earthquake resilience. Although, it is not under the NRA’s remit, we wanted to blaze trail for the local governments who are the ultimate custodian of resilient housing. Not all local governments have initiated the building permit system which we hope they will very soon. It will be also reference document for the the central level NRA’s successors mainly Ministry of Urban Development (MoUD) and National Disaster Risk Reduction and Management Authority (NDRRMA).

The manual has been divided basically into two sections; the horizontal extension and vertical extension which is expected to facilitate referencing. It is expected that the description of extension under various building typologies and conditions will enable technicians and other users to refer instantly.

This “Guidelines for Extension of Masonry Buildings” will be helpful guide to the partner organizations and house-owners. This guideline will orient the technicians for inspection, evaluation and correction of the extended rooms and storeys.

### Chandra Bahadur Shrestha

Executive Member  
National Reconstruction Authority

## Acronyms

3D	3-Dimensional
BMC	Brick Masonry in Cement
CGI	Corrugated Galvanized Iron
GoN	Government of Nepal
MR	Minimum Requirement
NNBC	Nepal National Building Code
NRA	National Reconstruction Authority
NSET	National Society for Earthquake Technology Nepal
RC	Reinforced Concrete
RCC	Reinforced Cement Concrete
SMC	Stone Masonry in Cement



## Table of Content

<b>Foreword</b> .....	<b>i</b>
<b>Acknowledgements</b> .....	<b>ii</b>
<b>Preface</b> .....	<b>iii</b>
<b>Acronyms</b> .....	<b>iv</b>
<b>1 Background</b> .....	<b>1</b>
<b>2 Scope</b> .....	<b>2</b>
2.1 Applicability .....	2
2.2 Limitations.....	2
2.3 Possible Extensions .....	2
<b>1 Horizontal Extension</b> .....	<b>3</b>
2.4 Cases of Horizontal Extension.....	3
2.4.1 Addition of one room at one of the widths of the building.....	4
2.4.2 Addition of two rooms at one of the lengths of building .....	5
2.4.3 Addition of wing walls to form a closed verandah at front of the building.....	6
2.4.4 Addition of wing walls to form a L verandah at front and side of the building .....	6
2.5 Minimum Requirements.....	7
2.5.1 Elements at the junction of the new and the existing walls .....	7
2.5.2 Connection of Roof members: .....	10
2.6 Construction Steps.....	11
<b>3 Alternative Method for horizontal extension:</b> .....	<b>17</b>
<b>4 Vertical Extension</b> .....	<b>20</b>
4.1 Possible vertical extension .....	21
4.1.1 Addition of a floor in the case of cement mortar: .....	21
4.1.2 Addition of floor in the case of mud mortar.....	23
4.1.3 Replacing light roofing with RC roofing .....	23
<b>5 References:</b> .....	<b>24</b>
<b>ANNEXES</b> .....	<b>25</b>



This Page is Intentionally Left Blank



## I BACKGROUND

Significant progress has been achieved in the private housing reconstruction in the aftermath of the 2015 Gorkha earthquake under the Government of Nepal (GoN) housing reconstruction programme that facilitated owner driven reconstruction through financial and technical assistance and inspections. More than 500,000 houses have now been completed, compliant to the prescribed technical requirements set forth by the National Reconstruction Authority.

The current progress is the outcome of key strategies implemented by the National Reconstruction Authority and supported by the timely development of various guidelines and manuals to aid the government officials, technical personnel, masons and house owners in the rebuilding process. The reconstructed houses have followed the Minimum Requirements (MRs) developed and enforced by the National Reconstruction Authority following provisions of the Nepal National Building Code. The MRs clearly stated that for buildings with stone/brick masonry in mud mortar, the number of stories are restricted to only one story if wooden band is used and up to one story plus an attic, if RC bands are used.

While these Minimum Requirements were in place to ensure safety, and have largely been followed by the reconstruction beneficiaries, the decrease in usable space in the houses that existed prior to the earthquake and that have been constructed during the reconstruction process is evident. The need for additional usable space is also apparent from the beneficiaries who opted the construction of hybrid structures, with lightweight upper floor using timber or metal posts and CGI sheet panels.



**Figure 1.** Typical stone masonry houses in Nepal before the earthquake (left) and reconstructed after the earthquake following Minimum Requirements (right). © NSET

Now, as the reconstruction and grant disbursement process completes, many beneficiaries are intending towards expanding their reconstructed building structure to add more usable space. It is, however, necessary to ensure that the additional structure also complies with the Building Code.

Therefore, in order to ensure safety of the additional structure against seismic and other loads, it has become an urgent task to develop and disseminate adequate measures with proper construction and connection details. This manual has been developed to support the engineers responsible for providing advice and assistance to the households for the implementation of expansion measures in their completed houses.

## **2 SCOPE**

### **2.1 Applicability**

This manual is applicable within certain prescribed limitation based on NNBC 105: 1994 seismic design code and as guided by NNBC 202, NNBC 203, Minimum Requirements (MRs), Correction and Exception Manual, Hybrid Manual and Light Timber/ Steel Frame Structure Manual.

The designs and details set forth in this manual are applicable only to masonry residential buildings that have been constructed after Gorkha Earthquake 2015 under the GoN housing reconstruction program. This manual aims to achieve the minimum acceptable structural safety as per envisioned by NNBC 105: 1994, seismic design code. The designs that are mentioned in the manual are ready-to-use designs for all annex structural components, though some of the provisions are set as advisory measures.

This guideline is mainly targeted for the houses, which have received all three tranches of support from the NRA. This gives a clear assumption that these houses do not have technical errors while constructing the main house. Here, 'main house' refers to the part of the house, which was approved by the NRA for the final tranche. Therefore, this document will primarily focus the feasible options of expanding the main house, the steps to follow to comply the added part of buildings with NNBC.

### **2.2 Limitations**

This manual only covers the design and details for expansion of load-bearing masonry building built with stone or brick masonry units and bonded with mud or cement mortars. The manual only applies to houses that has been newly constructed and have received the completion certificate with compliance to the Minimum Requirements set by the NRA. The options provided in this document are feasible options as a whole. If a competent engineer finds feasible options other than mentioned in this document, they can practise their jurisdiction. Any statements in this guideline if contradict with NNBC shall void the contradictory statements mentioned in this document.

### **2.3 Possible Extensions**

Several field level observation and studies have highlighted the key structural and architectural features of reconstructed houses. The most abundant structure across the earthquake affected regions are two-room stone masonry structures with an attic. In many of these cases, people have continued the use of their temporary shelters as kitchen, storage and living. Similarly, addition of light structures as annexes have also been witnessed in several cases. Thus, the expansion of houses is presented by comparing reconstructed houses with their damaged counterparts. It is assumed that if the homeowner had sufficient investment, time, resources and no obligations (related to code provisions) at the time of reconstruction, they might have built their house similar to their damaged houses. Hence, this guideline presents feasible cases of horizontal and vertical extensions to fulfil the need of additional space.

### 3 HORIZONTAL EXTENSION

Horizontal extensions are expected in cases when house owners have extra land to add further rooms in any side of existing house. However, the prime technical governing condition for this type of extension is length to breadth ratio (aspect ratio). There are various possibilities of extending a house in horizontal space; however, this guideline presents four typical modes of extensions. Different units like connections of the load bearing members, maintaining proper aspect ratio and keeping the integrity of buildings are to be taken into consideration while extending a house. Extending the existing building involves intensive works from foundation to roof, an engineer shall refer to NNBC to develop the components of extended building. An Engineer shall recommend the horizontal extension speculating the following points:

1. The existing building should have
  - a. been reconstructed under the Housing Reconstruction Programme of the Government of Nepal, National Reconstruction Authority (NRA) and,
  - b. been inspected and approved for all three tranches of government grant support and certified for completion by the NRA

The existing building structure or components of the building has not undergone any structural damage or problems related to settlement, tilting of walls and so forth.

(In case of structural problems in the structure, extension using this guideline is not recommended. However, a competent engineer can recommend the best alternative to extend, if possible, studying the severity of the problem.)

2. The length to breadth ratio of the building after proposed extension does not exceed three.  
(The competent technical personnel shall be able to judge which option will be best fit for the horizontal extension.)

#### 3.1 Cases of Horizontal Extension

In accordance with the prevalent limitations of the National Building Code, the main structure of a reconstructed stone or brick masonry building can be extended in horizontal direction following one of the following options:

- Addition of one room at one of the widths
- Addition of two rooms at one of the lengths
- Addition of wing walls to form a closed verandah at front of the building
- Addition of wing walls to form a L-verandah at front and side of the building

## Guidelines for Extension of Masonry Buildings

for houses that have been built during Earthquake Housing Reconstruction Programme

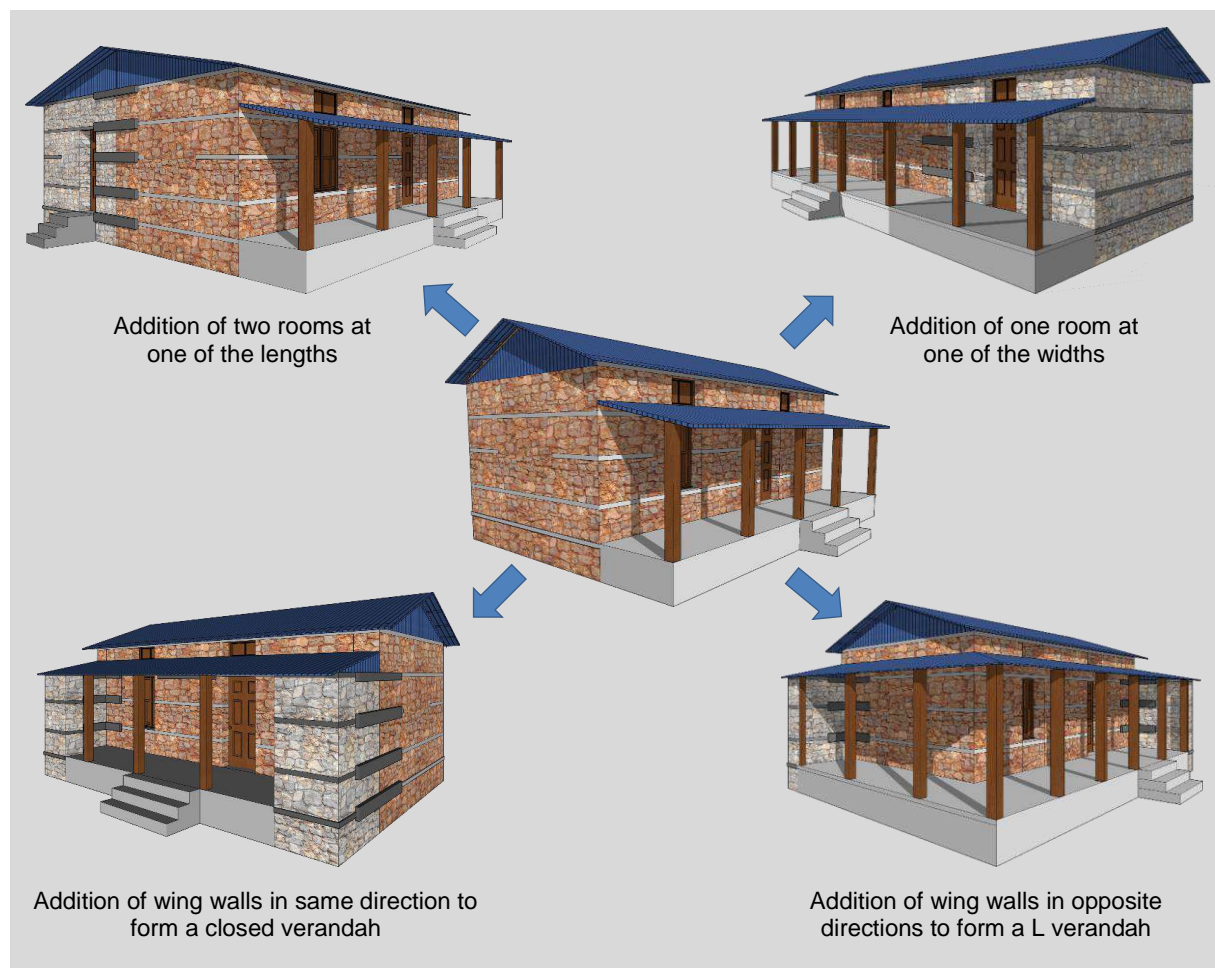

**Figure 2.** Feasible options for horizontal extension in stone or brick masonry buildings

### 3.1.1 Addition of one room at one of the widths of the building



**Figure 3.** Addition of one room at one of the widths of the building

In this case, a room can be added at one of the widths of the building (Figure 3). For this, C shape masonry walls must be constructed as the annex part and connected to the existing structure using "Band-Connectors" and shear keys. Horizontal and vertical reinforcements required in the construction of masonry buildings as per the NNBC must be followed in the added walls as well. While doing so, consideration must be made so as to ensure that the length to breadth ratio of the building does not exceed 3 (three). The existing floor and roof structure can also be extended along the added portion.



### 3.1.2 Addition of two rooms at one of the lengths of building

Another option for the extension of the masonry structure is the addition of two rooms at one of the lengths of building. For this, as in the above case, C shape walls are constructed as the annex part and are connected to the existing masonry walls using "Band-Connectors" and shear keys. Horizontal and vertical reinforcements required in the construction of masonry buildings as per the NNBC must be followed in the added walls as well. In this case however, the roof and floor structure need to be dismantled and rebuilt for the new structure.



**Figure 4.** Addition of two rooms at one of the lengths of the building

An alternative method of adding two rooms at one of the lengths can be achieved maintaining the continuation of the same slope of the existing roof as shown in Figure 5. However, following this process, the existing attic cannot be extended over the extended rooms. The advantage of this process over the method discussed above is that in this process the existing roof will be undisturbed, hence the cost of extension can be minimized. The roof over the added rooms can be constructed following NNBC. The detail drawings are presented in the Annex section.

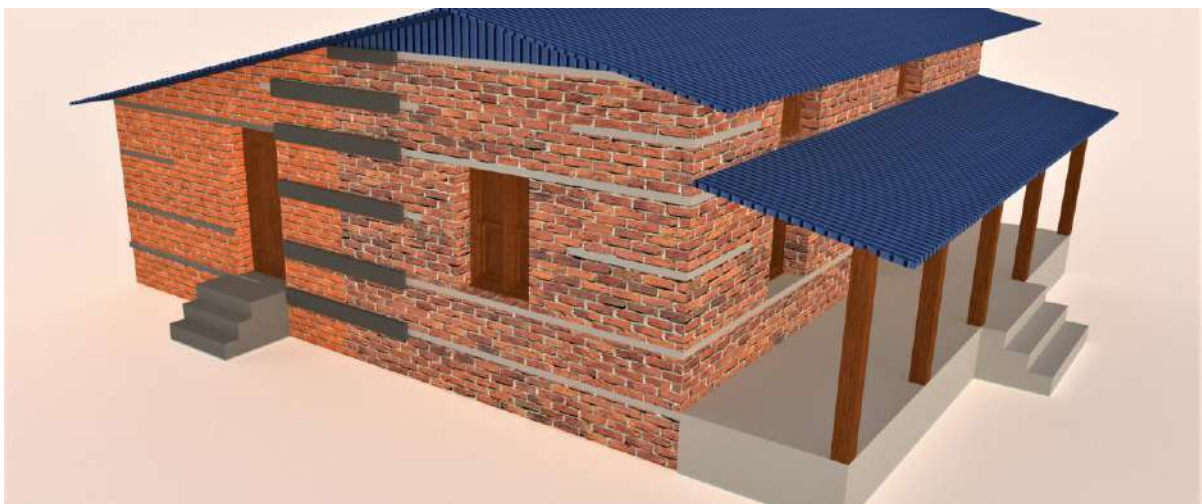

**Figure 5.** An alternative method of addition of two rooms at one of the lengths of the building

The practicality of this alternative method of addition of two rooms at one of the lengths depends on the height of added rooms at the end of down slope.

### 3.1.3 Addition of wing walls to form a closed verandah at front of the building

A prevalent construction technique in masonry buildings seen in the rural areas of Nepal is that of wing-walls that extend beyond the load bearing walls. These wing-walls perform as non-structural components, and provide additional usable space for verandah, storage and kitchen purposes. A similar construction technique is proposed in this guideline as well to increase the usable space of the building without any addition to the structural components.

As wing walls are unsupported walls, special consideration must be done to ensure that adequate connectivity is maintained with the existing load bearing structure. For this, Band-Connectors and shear keys are used while also providing adequate horizontal and vertical reinforcements in the new constructed walls.

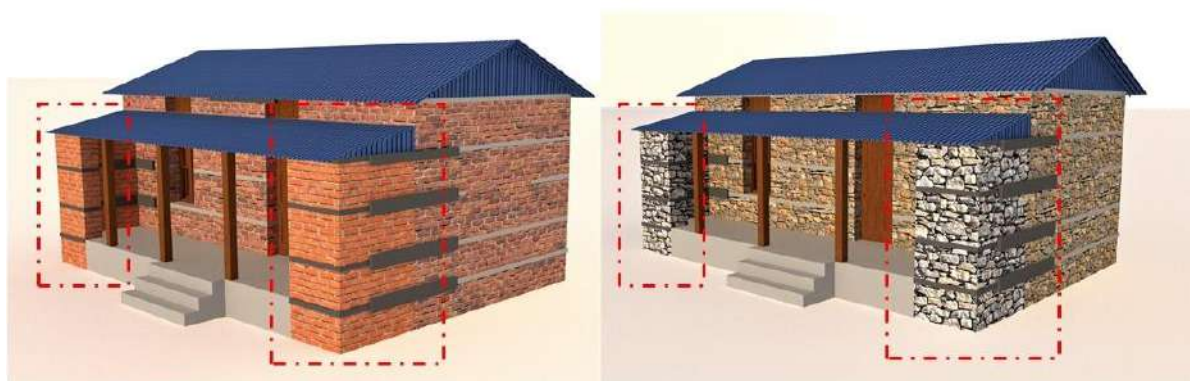

**Figure 6.** Addition of wing walls in same direction

### 3.1.4 Addition of wing walls to form a L verandah at front and side of the building

Similar to the extension above, wing walls can be constructed along two opposite sides of the building thus resulting in an L-shaped verandah across the building. Construction steps and considerations are similar to that prescribed in the above option.

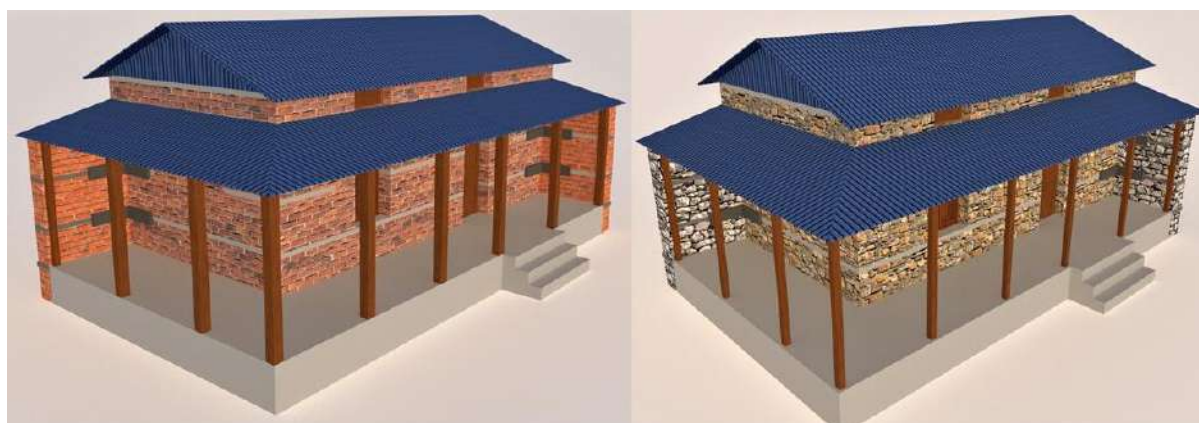

**Figure 7.** Addition of wing walls in opposite directions

## 3.2 Minimum Requirements

All the requirements related to footing, size of room, height of wall, bands, verticals and so forth to be fulfilled when extending a building shall comply the requirements mentioned in NNBC given for the construction of a new building. However, the connection between the existing wall and the new wall, the existing band and the new band, and the existing stitch and the new stitch should be followed as given in this document as these connections are not mentioned in the existing NNBCs.

### 3.2.1 Elements at the junction of the new and the existing walls

While rooms are added to existing buildings, it is important to maintain building's integrity and ensure proper transformation of earthquake forces. Considering this, the newly constructed walls and bands should be properly connected with the existing one. This can be achieved employing the following elements. These elements are used at the junction where the new wall meets the existing wall, whereas at other corners the detailing suggested by NNBC for new construction shall be followed.

#### A. Placement of the vertical reinforcement

Although there is presence of the vertical rebar in the existing wall, a vertical reinforcement shall be placed in the new wall as shown below (Figure 8 and 9). The dimension of the vertical and the embedding concrete shall be the same as suggested by the NNBC.

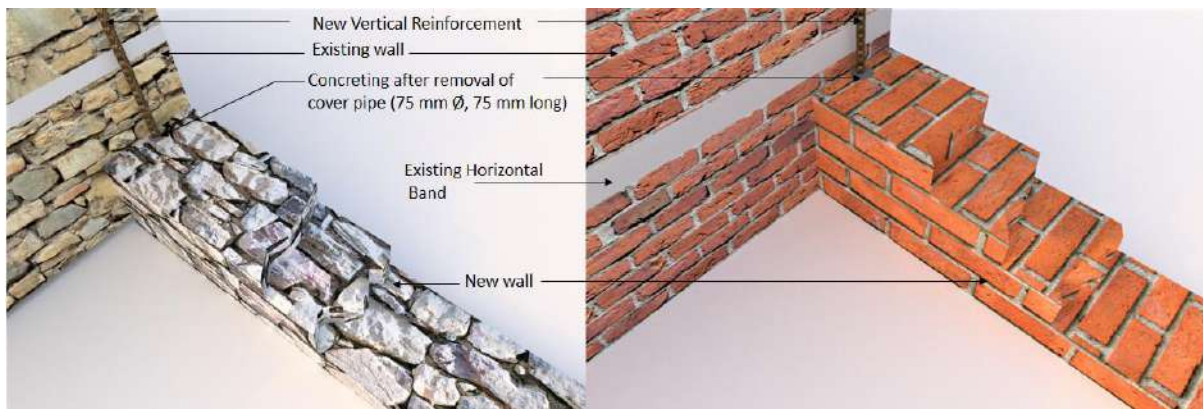

**Figure 8.** 3D depicting the placement of a new vertical rebar in stone masonry (left) and brick masonry (right) walls

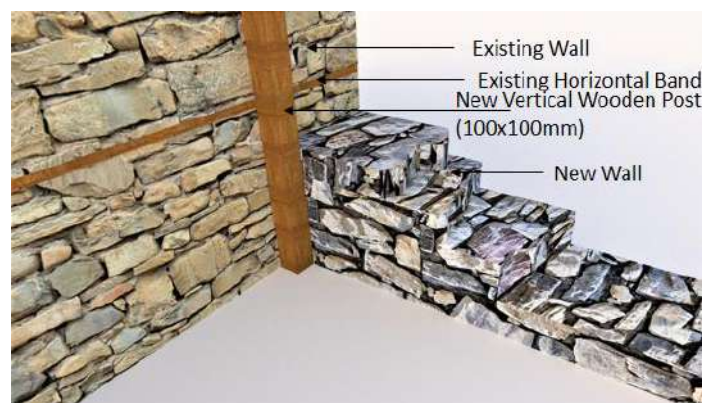

**Figure 9.** 3D depicting the placement of new wooden vertical

## B. Integrity between the added and the existing wall

To ensure the integrity between the added and the existing wall, dowels as shown in the Figure 10 and 11 below will be provided at every 450 mm height as the new wall progresses. The reinforcement dowels will be inserted through mortar joint embedding in 1:3 cement sand mortar whereas stone keys will be placed by withdrawing the unit of stone.

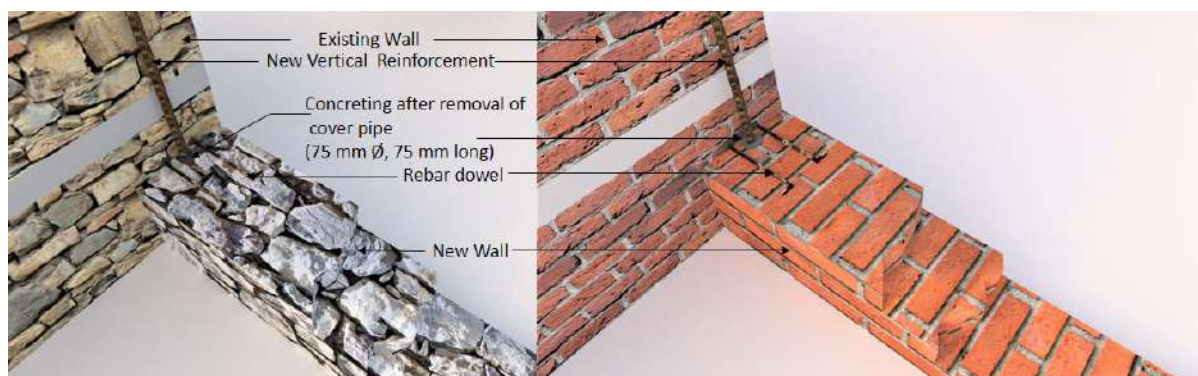

**Figure 10.** Dowels connecting the existing wall and the new wall in case of reinforced concrete



**Figure 11.** Stone dowels connecting the existing wall and the new wall in case of wooden reinforcement

## C. Connection between the existing and the new bands/stitches:

It is not feasible to provide a continuous band in the existing wall and the new wall, as it requires the demolition and the recasting of some length of existing walls/bands/stitches of the corner at which the new wall comes in contact with the existing wall.

To solve this problem, an element to connect the existing band/stitch and the new band/stitch has been devised which is termed hereafter as a Band-Connector. The 3D drawing depicting the use of the Band-Connector is shown below (Figure 12 to 16). The details of these connectors are presented in the Annex.

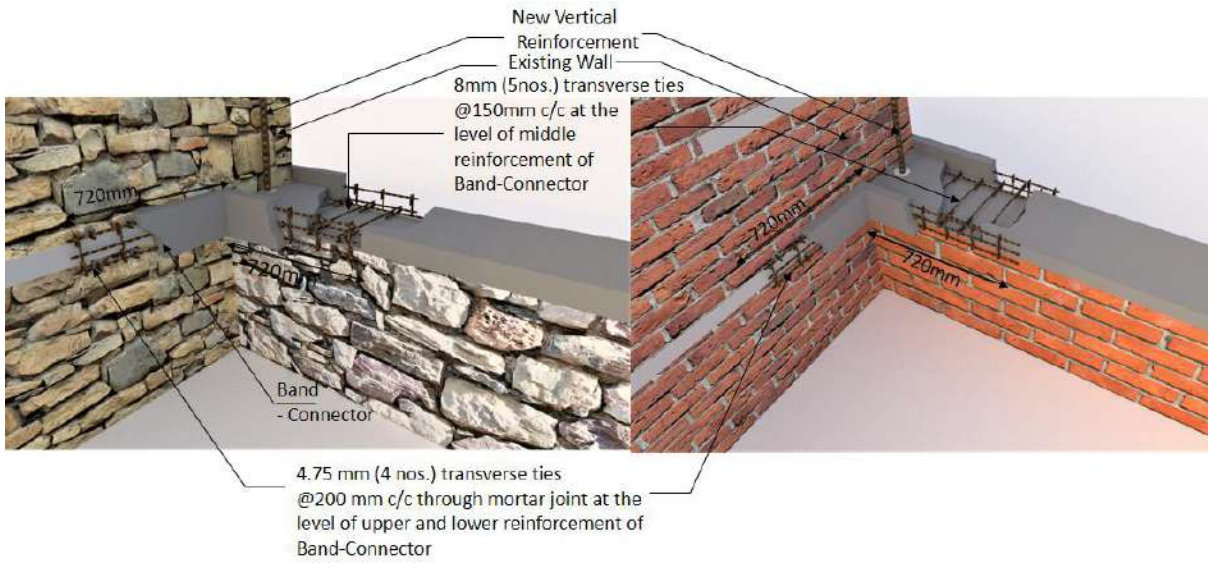

Figure 12. 3D view of RCC Band-Connector (perspective from the added room)

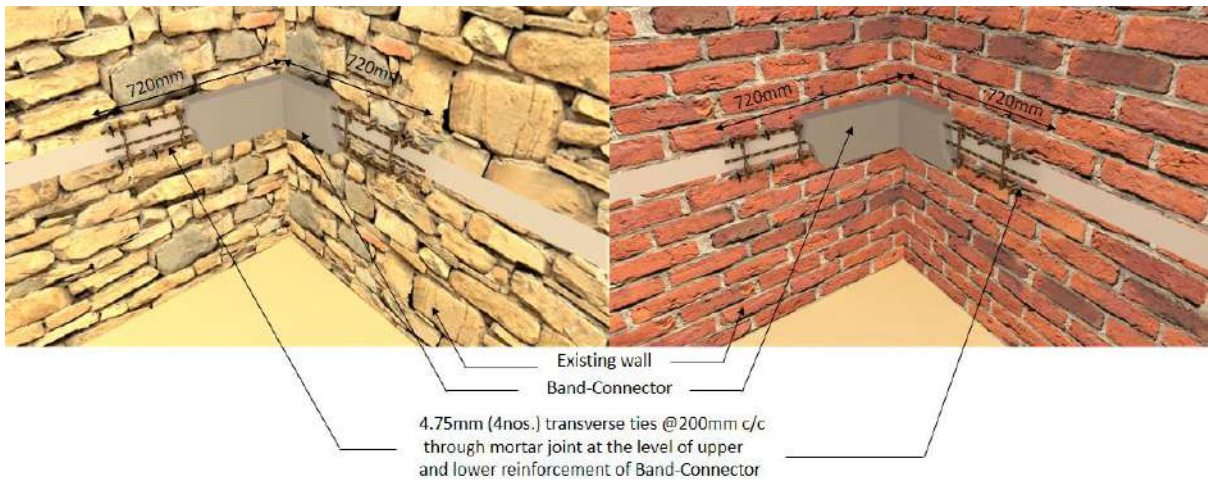

Figure 13. 3D view of RCC Band-Connector (Perspective from the existing room)

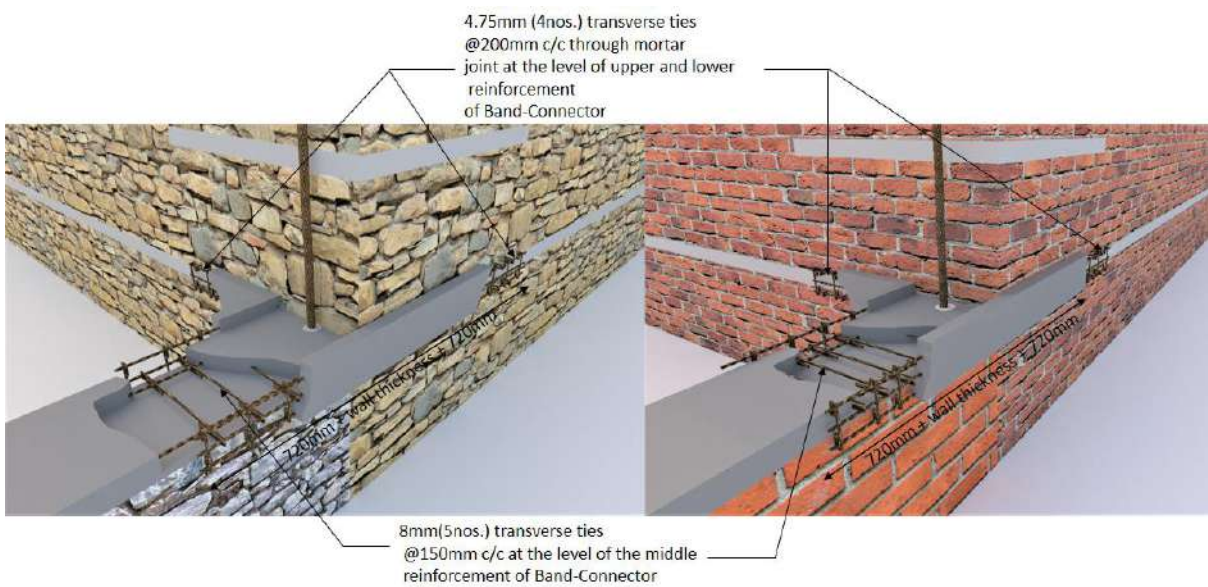
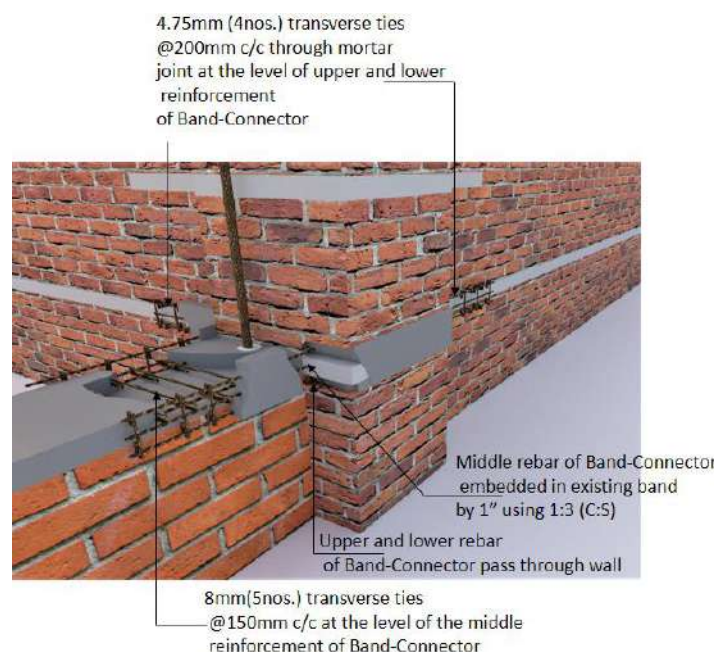

Figure 14. 3D view of RCC Band-Connector (Perspective from outside wall)

## Guidelines for Extension of Masonry Buildings

for houses that have been built during Earthquake Housing Reconstruction Programme



**Figure 15.** 3D view of Band-Connector (In case of brick masonry wall with Kopla projection)

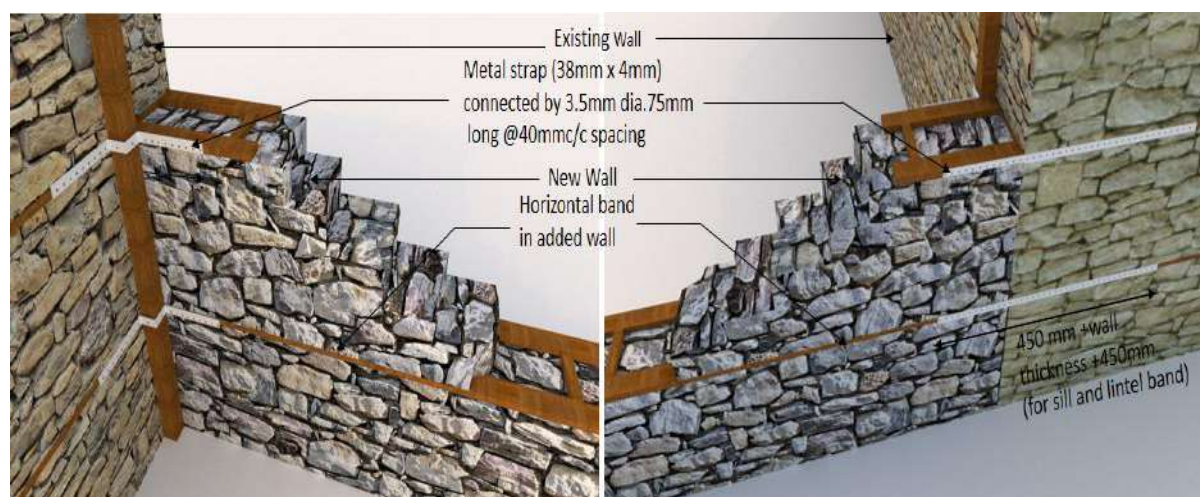

**Figure 16.** 3D view of Wooden Band-Connector, perspective from added room (left) and outside wall (right)

### 3.2.2 Connection of Roof members:

There are various roofing materials, such as stone slabs, slates, mud roofing, tiles or jhingati, thatched roof, CGI roof and so forth provided by NNBC, however it recommends the use of light roofing materials. And so far, CGI roofing is the widely used roofing material in rural Nepal. Therefore, typical connection details depicted in Figure 17 is for members used in CGI roofing. The details, such as spacing and size of rafters, size of ridge beam which depend on the span and therefore can vary from one building to next are sufficiently elucidated in NNBC. Hence, it is recommended to follow NNBC according to building characteristics.

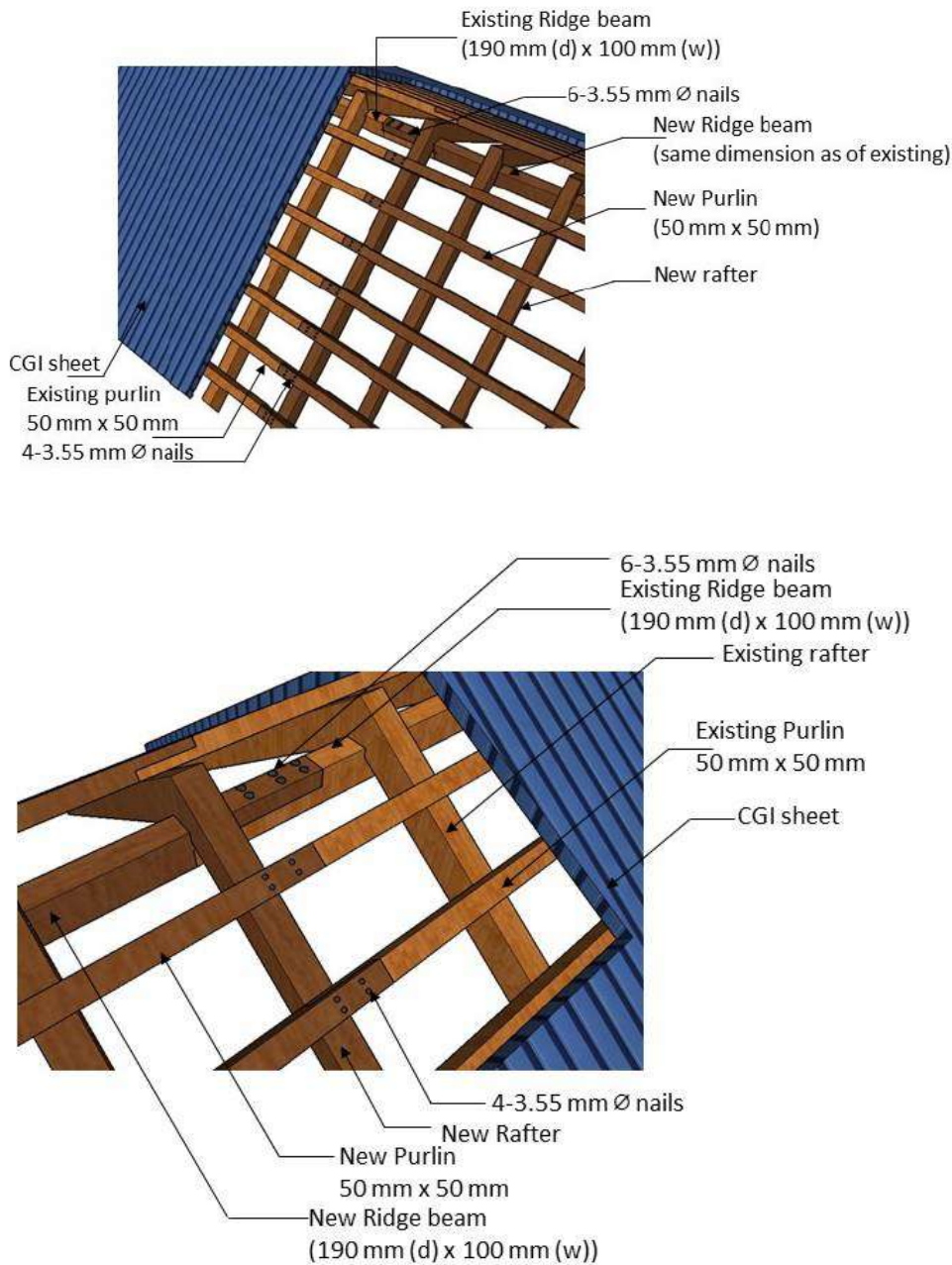

**Figure 17.** Typical connection details of Purlin and Ridge Beam to be followed while extending the roof

### 3.3 Construction Steps

The construction of the added room can be accomplished following the construction steps that are followed for the construction of a new building. However, the construction at the joint where the new wall and the existing wall meets has to follow the following procedures to ensure the connection between two walls/bands/stitches:

### Case A: Existing bands of reinforced concrete

1. The foundation of new wall should be constructed as per specification of NNBC 202/203:2015. However, the connection of new and the existing foundation can be ensured following the steps depicted in Figure 18 below.
2. The plaster over the existing walls which forms interface with the new wall, bands and stitches shall be removed.
3. A vertical reinforcement bar shall be placed at the corner of new wall as shown in Figure 8 and Figure 18.
4. Connection between the existing foundation and the new foundation shall be provided as shown in Figure 18.
5. Construct the plinth band as suggested by NNBC. If the existing plinth band is of reinforced concrete, connect the new plinth band with the existing plinth band using the Band-Connectors as shown in Figures 12-16. In this case, it is not possible to provide Band-Connectors from every side, therefore, it is suggested to provide Band-Connectors wherever possible.
6. While progressing the construction of the new wall, integrity between the added and the existing wall should be provided employing the dowels as shown in Figure 10.

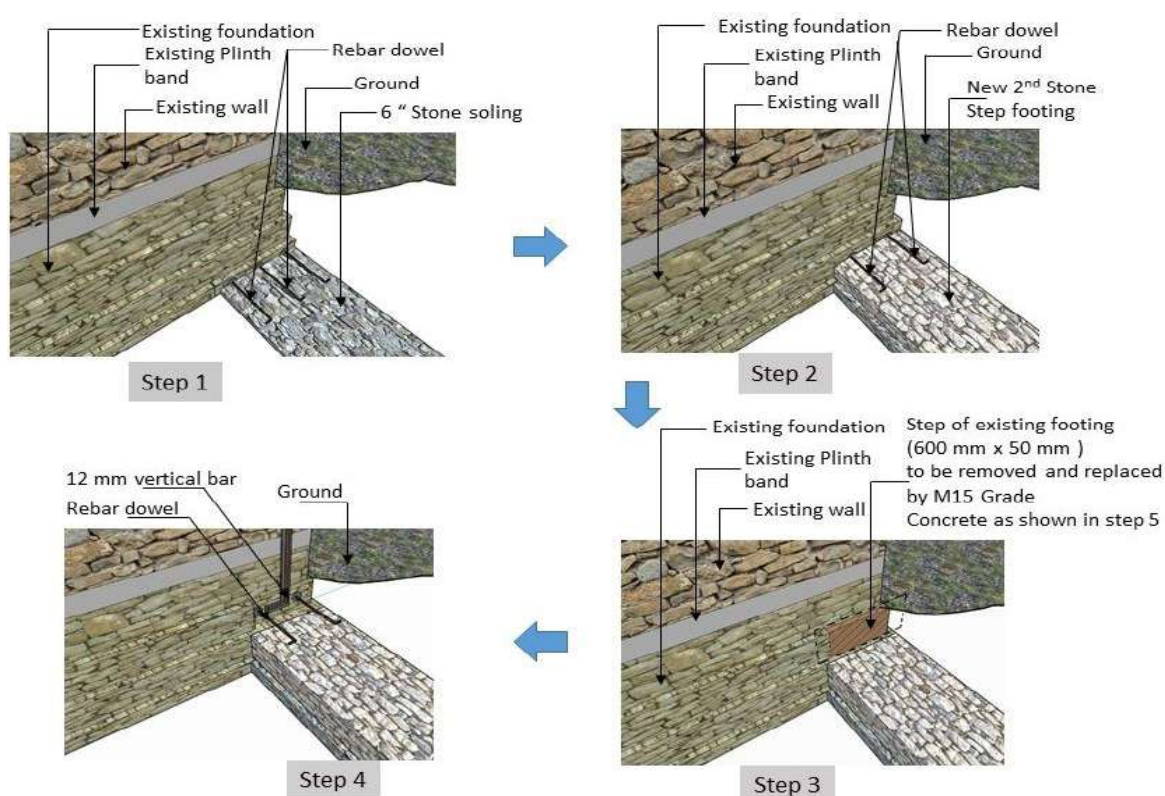



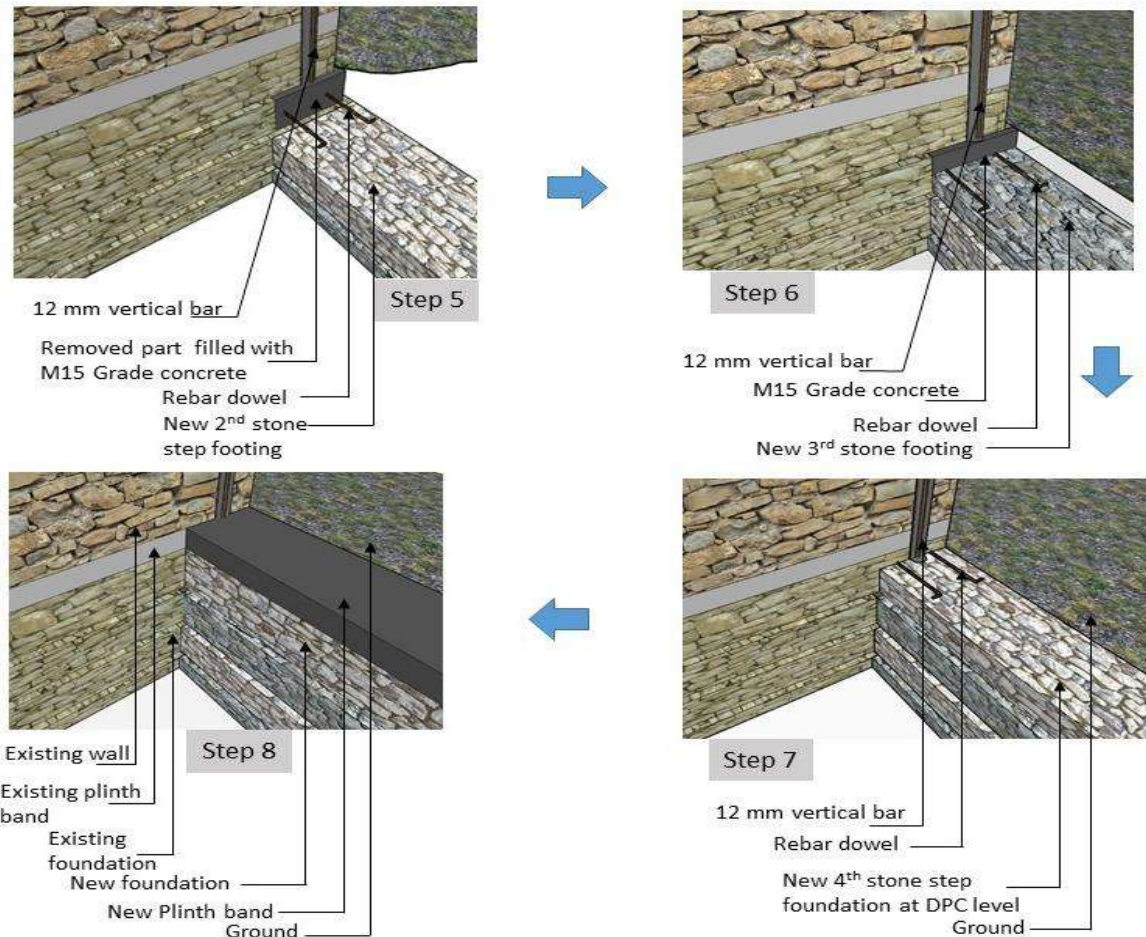

**Figure 18.** Typical details showing the connection between the existing foundation and new foundation (Case: concrete available)

7. A Band/stitch will be placed over the new walls at the level of a band/stitch of the existing walls. There should not be any discrepancy in the level between the existing band/stitch and the new band/stitch. Before casting a band/stitch, the connections between the reinforcements of a band/stitch and the Band-Connector should be ensured. This can be obtained by:

- a. 3-12 mm longitudinal reinforcements of the Band-Connector will be transversely tied using 8 mm ties at 150 mm c/c. These ties will be in vertical plane.
- b. Band-Connectors will be as per the requirements below:

**i. In case of new walls:**

Middle longitudinal reinforcements of the inner Band-Connector and the outer Band-Connector will be tied using 8 mm ties at 150 mm c/c (Refer Figure 12 and 14). These ties will be in horizontal plane. The horizontal plane of middle reinforcement of the Band-Connector will be in the same horizontal plane of the reinforcements of a band/stitch. This will be followed by casting of a band/stitch and the Band-Connector.

**ii. In case of existing walls:**

The presence of existing band/stitch hinders the provision of the same connection discussed just above in the case of new walls. Unlike the connections between inner and outer band-connectors provided in case of new walls, here, the connection between inner and outer band-

connectors will be done at the level of top and bottom reinforcements of band connectors (Refer Figure 12, 13 and 14). To achieve this, drilling in the existing wall is done at 200 mm c/c at the level of top reinforcements of band connectors. 4.75 mm through ties will be passed to connect top reinforcements of inner and outer band-connectors. This process will be repeated at the level of lower reinforcements of band-connectors. These through ties should be encased in 1: 3 mortar to protect them from corrosion.

8. The connection using the Band-Connector will be provided at every stitch/ band level.
  - a. Special provision in case of RC Band-Connectors to be used over topmost band of a house  
Band-Connectors shown in Figure 12, 13 and 14 can be installed in other band levels except at the topmost band of house. The details of RC Band-Connectors to be used at the topmost band of a house are shown in the Annex.

#### **Special provision in case of RC Band-Connectors where there is presence of Kopla**

Koplas are common in case of 9” thick BMC walls. These presence hinder the placement of the RC Band-Connector depicted in Figure 12, 13 and 14. When such a situation comes, it is suggested to cast the modified RC Band-Connector of leg length 720 mm or 600 mm depending on the field situation as shown in Figure 15. The presence of Kopla hinders the continuation of longitudinal bars of Band-Connector. In such case, top and bottom bars of Band connectors can be made continuous withdrawing the brick units above and below the bands present in Kopla. However, it is not feasible to maintain the continuity of the middle reinforcement of Band-Connector as it encounters concrete band. Therefore, middle reinforcement will be embedded in existing band present in Kopla by an inch using rich cement mortar (1:3). The details are shown in the Annex.

- b. **Special provision in case of RC Band-Connectors where the available space will be limited to 600 mm**

The sample buildings that are referred to develop the Band-Connectors are the most prevalent buildings in the reconstructed area. In these buildings, the placement of Band-Connectors, of 720 mm leglength, will not have space constraint to be casted. However, NNBC allows that openings can be positioned at least 600 mm apart from the inner corner. Due to this provision, there can be a possibility for an opening to be located at 600 mm in one or both existing walls of some buildings. If this is the scenario, the Band-Connector of 720 mm cannot be placed due to limitation in space availability. In such positions only, a Band-Connector of 600 mm leg length can be used. The details of which is shown in the Annex. Therefore, there is a possibility of employing both Band-Connectors of leg length 720 mm and 600 mm in the same building as per the field conditions.

#### **Case B: Existing bands of Timber**

1. The foundation of new wall should be constructed as per specification of NNBC 202/203:2015. However, the connection of new and the existing foundation can be ensured following the steps depicted in Figure 19 below.
2. A vertical timber member shall be placed at the corner of new wall as shown in Figure 9.

3. While progressing the construction of the new wall, integrity between the added and the existing wall should be provided employing the dowels of stones as shown in Figure 11.
4. A Band/stitch will be placed over the new walls at the level of a band/stitch of the existing walls. There should not be any discrepancy in the level between the existing band/stitch and the new band/stitch. Here, the Band-Connector provided will be of metal strap as shown in the Figure 16.
5. The connection using the metal strap Band-Connector will be provided at every band: Plinth band, sill band, lintel band, stitches and roof band.

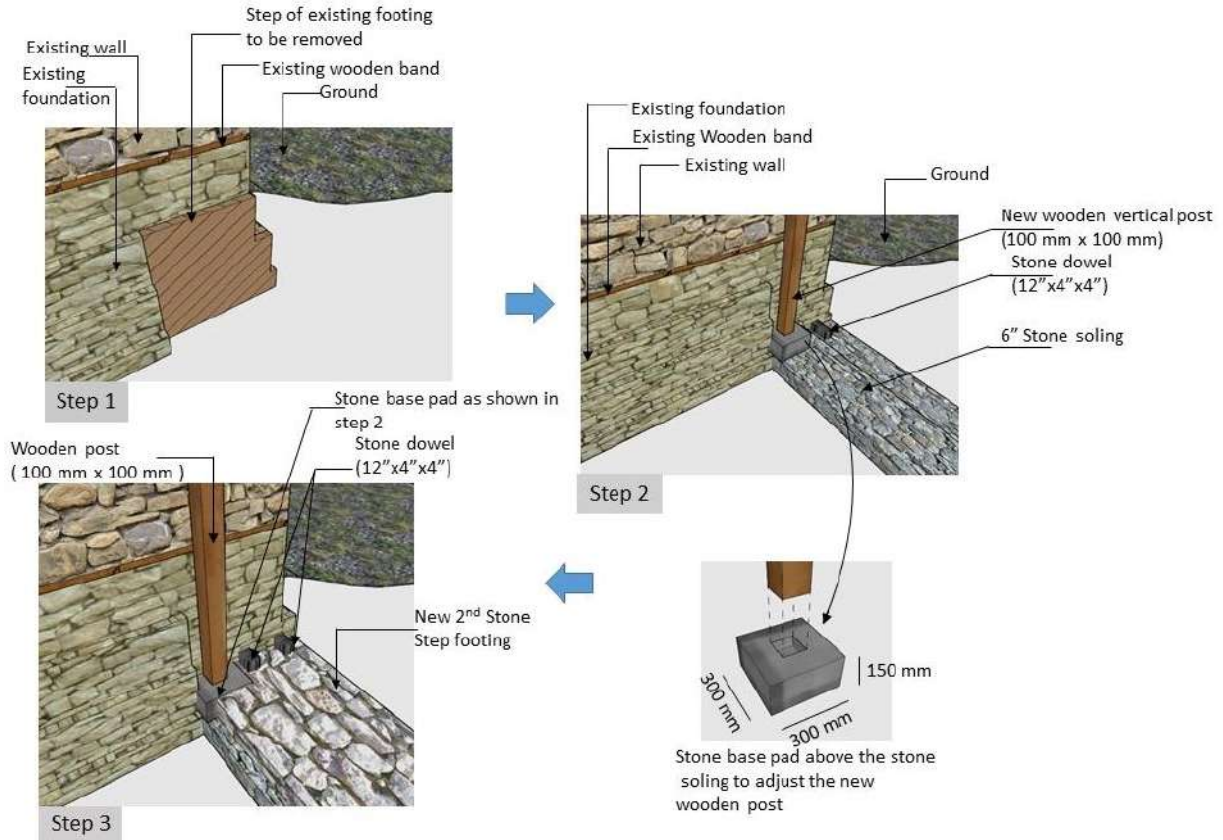

### Guidelines for Extension of Masonry Buildings

for houses that have been built during Earthquake Housing Reconstruction Programme

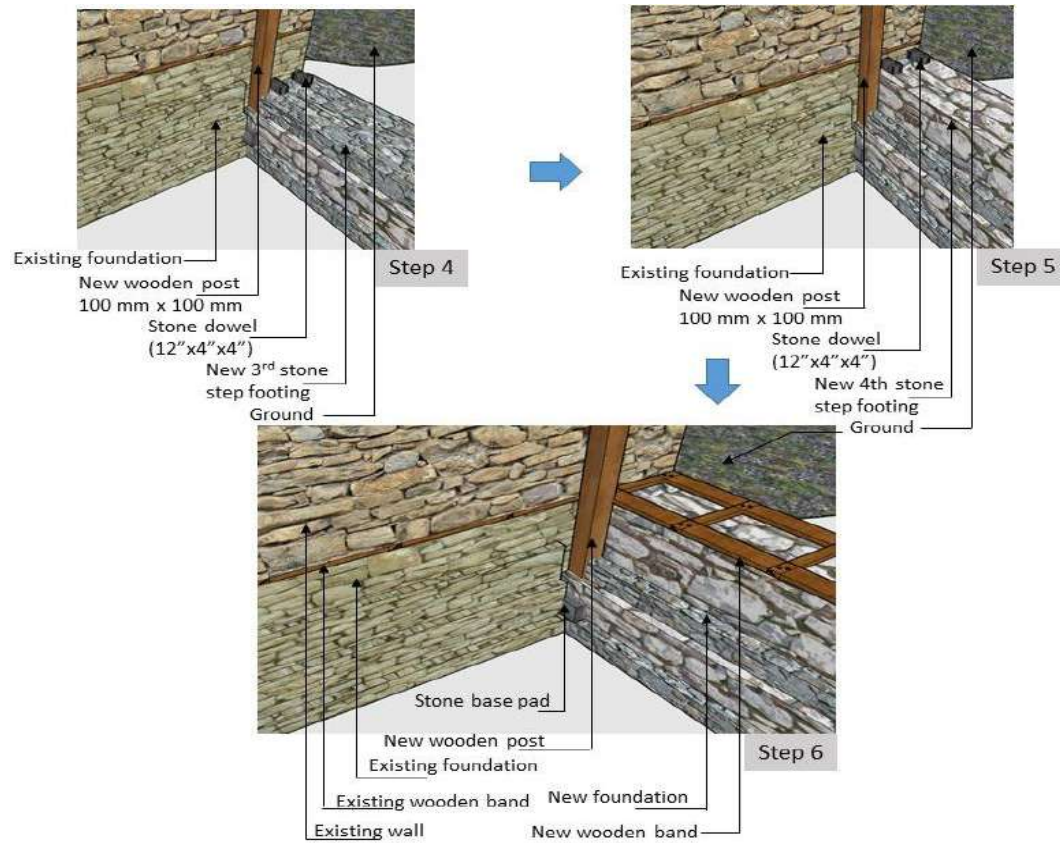

**Figure 19.** Typical details showing the connection between the existing foundation and new foundation (Case: concrete unavailable)

## 4 ALTERNATIVE METHOD FOR HORIZONTAL EXTENSION:

In addition to the horizontal extension discussed above, horizontal extension can be done stiffening the new wall with the aid of buttresses. In this method, Band-Connectors need not have to be provided to connect the existing wall and new wall as the provision of buttresses stiffens the new wall.

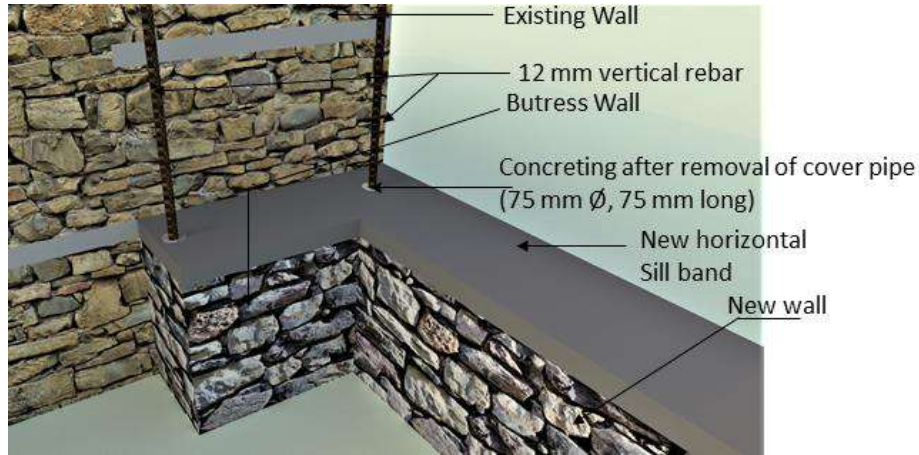

**Figure 20.** Provision of buttress to stiffen the new wall where cement and reinforcement are available in case of Stone masonry

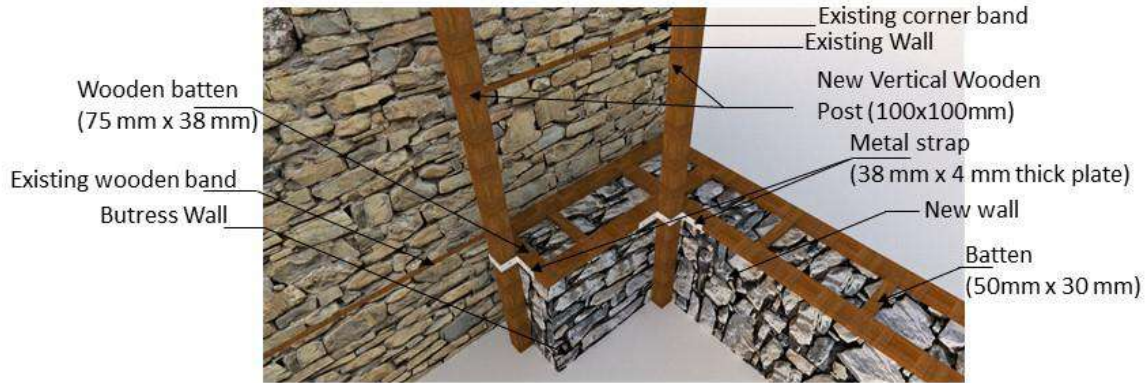

**Figure 21.** Provision of buttress to stiffen the new wall where cement and reinforcement are not available in case of Stone masonry

## Guidelines for Extension of Masonry Buildings

for houses that have been built during Earthquake Housing Reconstruction Programme

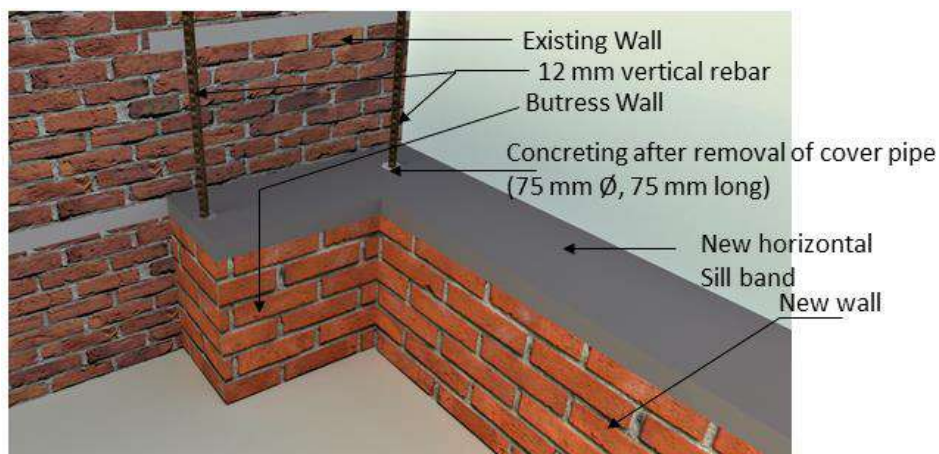
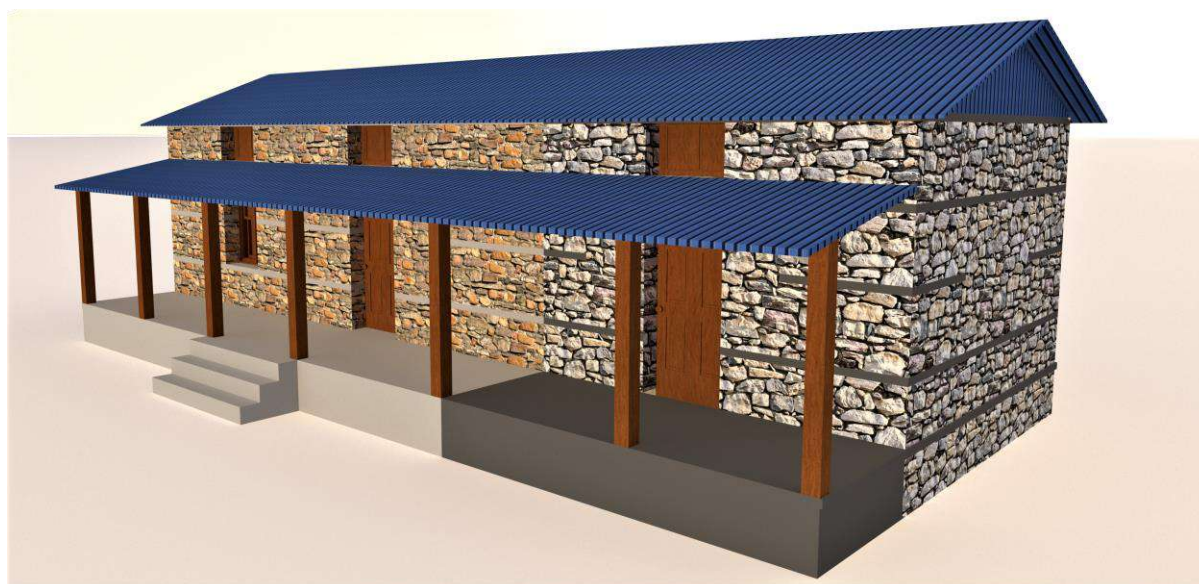

**Figure 22.** Provision of butress to stiffen the new wall where cement and reinforcement are available in case of brick masonry

As this method does not employ the Band-Connector, there will not be any outward projection of Band-Connector which makes the facade of masonry looks more aesthetic in this case than the extension done using the Band-Connector. However, the application of buttresses occupies more usable space of room. Among the horizontal extensions discussed above, this method is feasible for:

- a. Addition of a room at one of the widths
- b. Addition of two rooms at one of the lengths

The 3D views of above two case are presented below:



**Figure 23.** Addition of a room at one of the widths with the provision of buttresses in case of stone in mud building

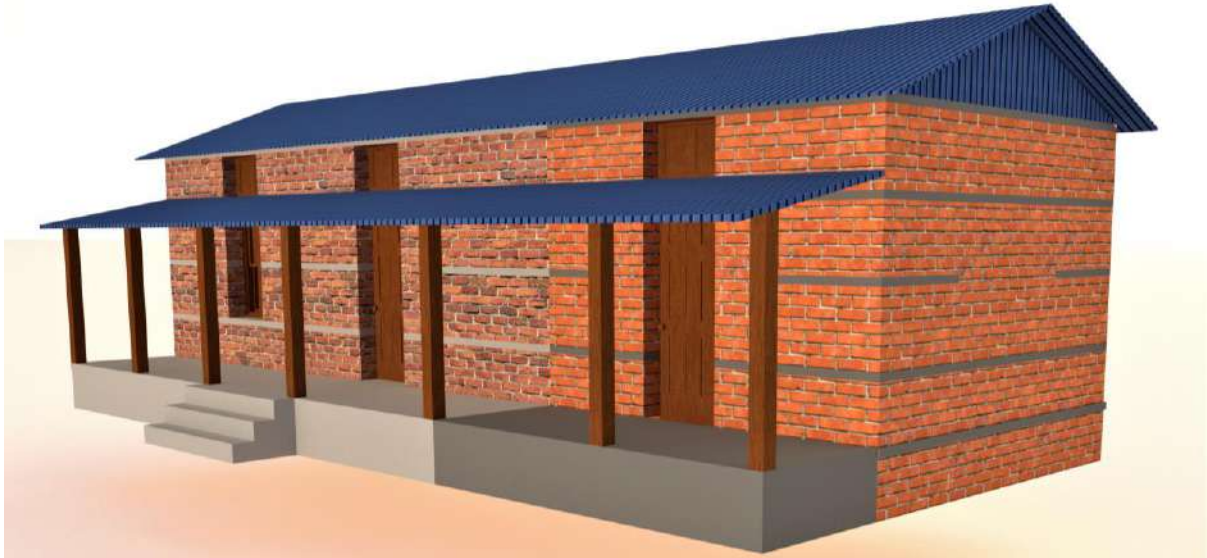

**Figure 24.** Addition of a room at one of the widths with the provision of buttresses in case of brick in cement building

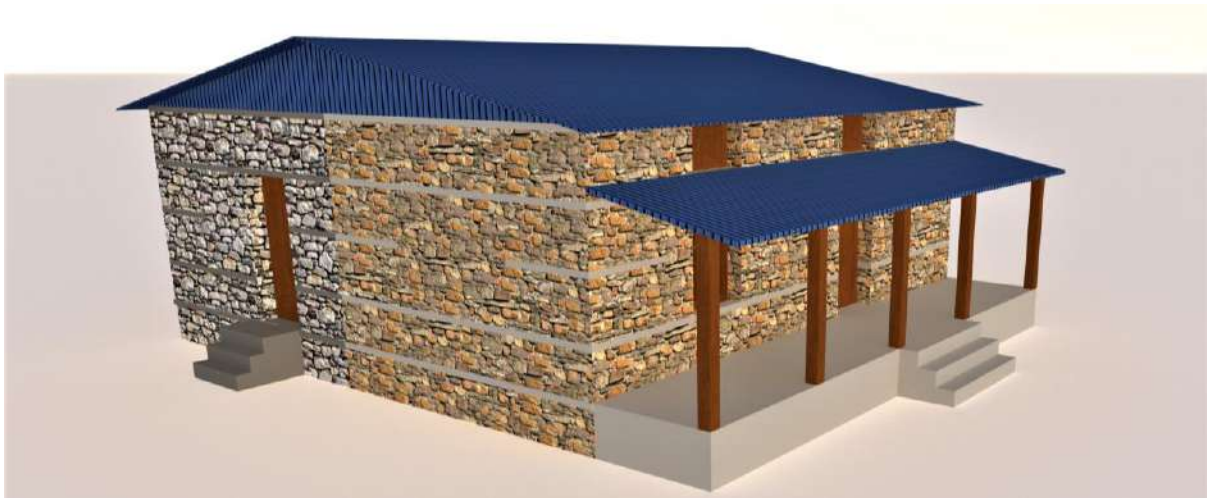

**Figure 25.** Addition of two rooms at one of the lengths with the provision of buttresses in case of stone in mud building



**Figure 26.** Addition of two rooms at one of the lengths with the provision of buttresses in case of brick in cement building

## 5 VERTICAL EXTENSION

Vertical Extensions are mainly proposed in such cases where there is not enough land or owners do not prefer to add rooms horizontally any further. The extension in such cases is primarily governed by the load carrying capacity of the existing main structure. Vertical extensions are possible in the case where the main structure (existing ground storey structure) satisfies the requirements stated in NNBC for the final structure that results after a vertical extension. Competent Technical Personnel shall recommend the feasible vertical extension judging the followings:

1. The existing building should have
  - a. been reconstructed under the Housing Reconstruction Program of the Government of Nepal, National Reconstruction Authority (NRA) and,
  - b. been inspected and approved for all three tranches of government grant support and certified for completion by the NRA
2. The existing building structure or components of the building has not undergone any structural damage or problems related to settlement, tilting of walls and so forth.

(In case of structural problems in the structure, extension using this guideline is not recommended. However, a competent engineer can recommend the best alternative to extend, if possible, studying the severity of the problem.)

3. The existing foundation depth and width suffices the requirements of the building resulting after the extension.

The existing walls of the ground storey have the minimum thickness that NNBC states for the building structure resulting after the extension.

4. The size of the verticals used in critical sections of the existing building have a minimum dimension that NNBC states in the ground storey of two storied buildings.

In case of buildings that do not meet the structural requirements as suggested above (3, 4 and 5), the structural capacity will not suffice to support the addition of storey using the parent material used in the ground storey. If this is the scenario but the house owner is in a dire need of a vertical extension, an extension in the vertical direction can be proposed using lightweight materials following the design requirements in the Hybrid Manual published by the National Reconstruction Authority. Apart from that, an addition of a storey using the parent material can be done after carrying out the structural improvement of the existing building structure following the design provided by a competent engineer/designer.

In case of buildings satisfying the above requirements, a few feasible options are discussed here.



## 5.1 Possible vertical extension

The feasible vertical extensions for brick and stone masonry structures are listed in Table 1 below. Possible modes of vertical extension/ modification in brick and stone masonry buildings

**Table 1: Possible vertical extension of buildings with respect to building typology**

S.N.	Existing Building Typology	Possible Extension/Modification as per NNBC
1	Building in Cement Mortar	<ul style="list-style-type: none"> <li>a. Addition of an attic using the same parent material</li> <li>b. Addition of a storey using the same parent material</li> <li>c. Addition of a storey and an attic using the same parent material</li> <li>d. Addition of a storey using light materials</li> </ul>
2	Building in Mud Mortar	<ul style="list-style-type: none"> <li>a. Addition of an attic</li> <li>b. Addition of a storey using light materials</li> </ul>
3	Changing the roof	<ul style="list-style-type: none"> <li>a. Replacing light roof with RC roof</li> </ul>

### 5.1.1 Addition of a floor in the case of cement mortar:

If the mortar used while constructing the ground story is cement mortar, addition of a story, or a story and attic is allowed according to Nepal National Building Code. However, the following requirements stated by NNBC-202/2015 should be fulfilled by the existing ground storey for an addition of a storey using the same parent material, otherwise a vertical extension using the same parent material will not be a feasible option.

**Table 2: MRs to extend vertically using the same parent material**

	Stone Masonry in Cement (SMC)	Brick Masonry in Cement (BMC)
<b>Existing wall thickness of ground storey, mm</b>	350	350
<b>Existing Base width of footing</b>	Soft soil, mm	*
	Medium Soil, mm	800
	Hard Soil, mm	600
<b>Existing Depth of footing, mm</b>	900	900
<b>Diameter of vertical reinforcement bars used in critical sections of the existing ground storey, mm</b>	16	16

\* Two-storied buildings with load-bearing stone masonry of random rubble or half-dressed stone are not recommended in soft soil

If any of the Minimum Requirements stated above is not fulfilled, it is not recommended to extend vertically using the same parent material, the feasible option here will be extending vertically using light structures following the Hybrid Manual, endorsed by NRA, GoN.

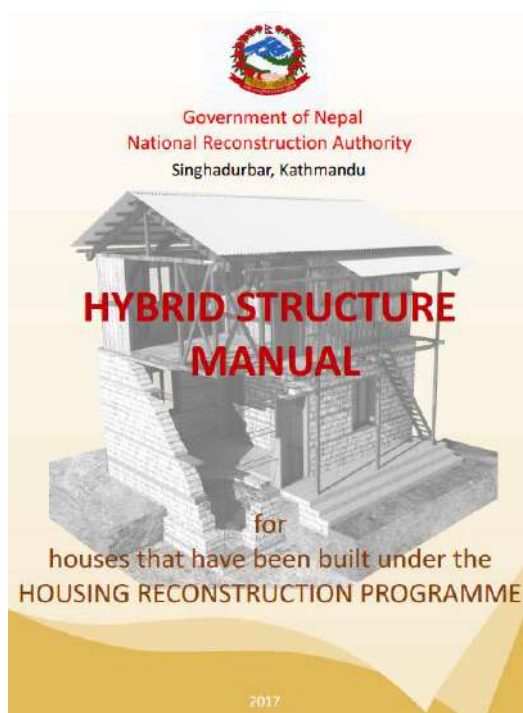

Figure 27. Hybrid Structure Manual

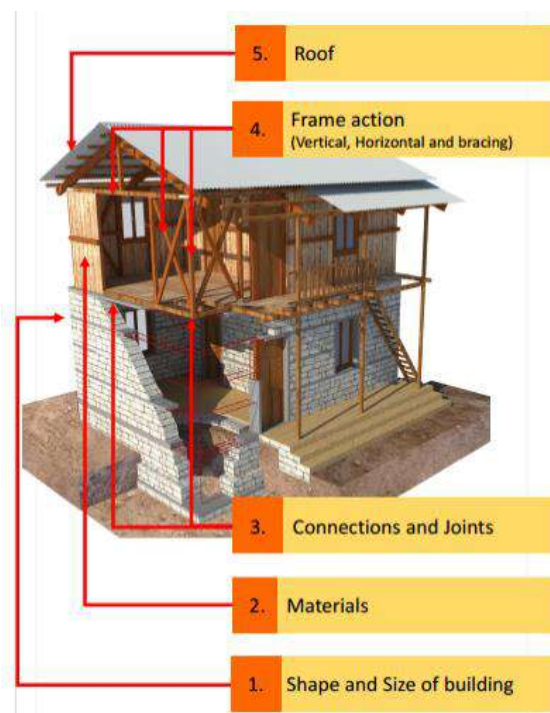

Figure 28. Key elements of Hybrid structure (Reference: Hybrid Structure Manual, NRA, GoN)

The Hybrid Structure Manual presents the implementable methods of extending the house vertically using light frame members, especially timber frames as shown in figures 27 and 28 above. It focuses on the use of timber members as frames and cladding using wooden planks, CGI sheets and so forth. It exhaustively discusses the connection between the existing structure and the new structure, and the connection between their components.

However, if houseowner wants to extend vertically the house, which does not satisfy MRs, presented in Table 2, using the same parent material (brick or stone), they can seek a competent engineer to retrofit/ strengthen the existing storey of the house before extending the house vertically.

Whereas if the ground storey satisfies the Minimum Requirements mentioned above, a vertical extension is possible using the same parent material. This can be done simply following the NNBC, however, there can be a challenge regarding the continuity of the vertical rebars. This can be ensured following the following procedures:

- Dismantle the existing roof so attentively that the same holes in the CGI sheets can be used again. This will prevent the leakage from the roof. For this, masons can number the CGI sheets before dismantling and fit them using the same number order when they must assemble again after constructing the attic.
- Disassemble other components of the roof cautiously so that these elements can be used again.
- The vertical rebars coming from ground story, which used to be bent round the wall plate, roof band should be straightened, and this straightened reinforcement should be employed to provide the lapping. Lapping should not be less than 60 times the diameter of the verticals. If the reinforcement coming from the ground story, which was bent over the wall plate or roof

band, is less than 60 times the diameter of the verticals, it is recommended to drill through the roof band and take out the units below the roof band from the wall at corners, jambs of the openings and at where there are verticals coming from the ground story so that sufficient lapping can be done.

- After ensuring the continuity of the verticals, the procedures that is used to construct a new storey can be followed

### 5.1.2 Addition of floor in the case of mud mortar

1. If the single storied houses were built in mud mortar, they can have an attic extended provided that these houses consist of RC bands, whereas those houses consisting of wooden bands are not recommended to have an addition of an attic. The addition of an attic can be done simply following the NNBC, however, the key challenge is to maintain the continuity of the existing vertical rebar which can be ensured following the same steps discussed in section above.
2. If the mortar involved while constructing the ground story is low strength mortar (mud mortar), addition of a story is not allowed as per National Nepal Building Code. However, the guideline 'Hybrid Structure Manual' prepared by National Reconstruction Authority, Government of Nepal allows the addition of a story using light materials, such as CGI sheets, timber. Hence, those house owners who have constraints to extend horizontally can extend vertically following the Hybrid Structure Manual if they need additional rooms.

### 5.1.3 Replacing light roofing with RC roofing

This option is feasible in case of strong mortar (cement mortar). NNBC do not recommend the use of heavy roof in case of low strength mortar. The replacement of light roofing with RC Roof can be accomplished following the NNBC.

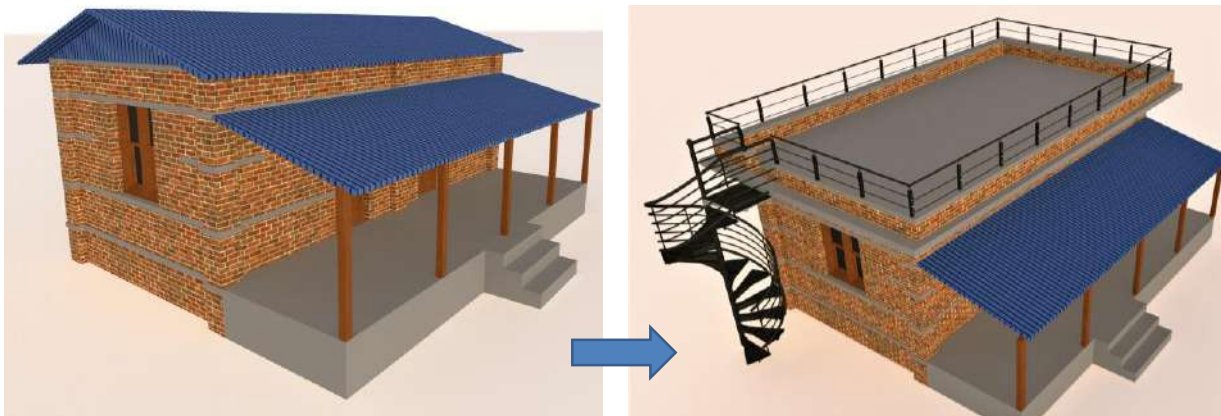

**Figure 29.** Showing the transformation of the building after replacing light roof with RC roof

## **6 REFERENCES:**

NNBC105: 1994, Seismic Design of Buildings in Nepal

NNBC 203: 2015, Guidelines for Earthquake Resistant Building Construction: Low Strength Masonry

NNBC 202: 2015, Guidelines on: Load Bearing Masonry

Correction/Exception Manual for Masonry Structure for Houses that have been Built Under the Housing Reconstruction Programme

Hybrid Structure Manual for Houses that have been Built under the Housing Reconstruction Programme

How to Extend your House Safely, Part A: A Guide for Extending your House at the Ground Floor, Prepared by United Nations Development Programme (UNDP)

## ANNEXES

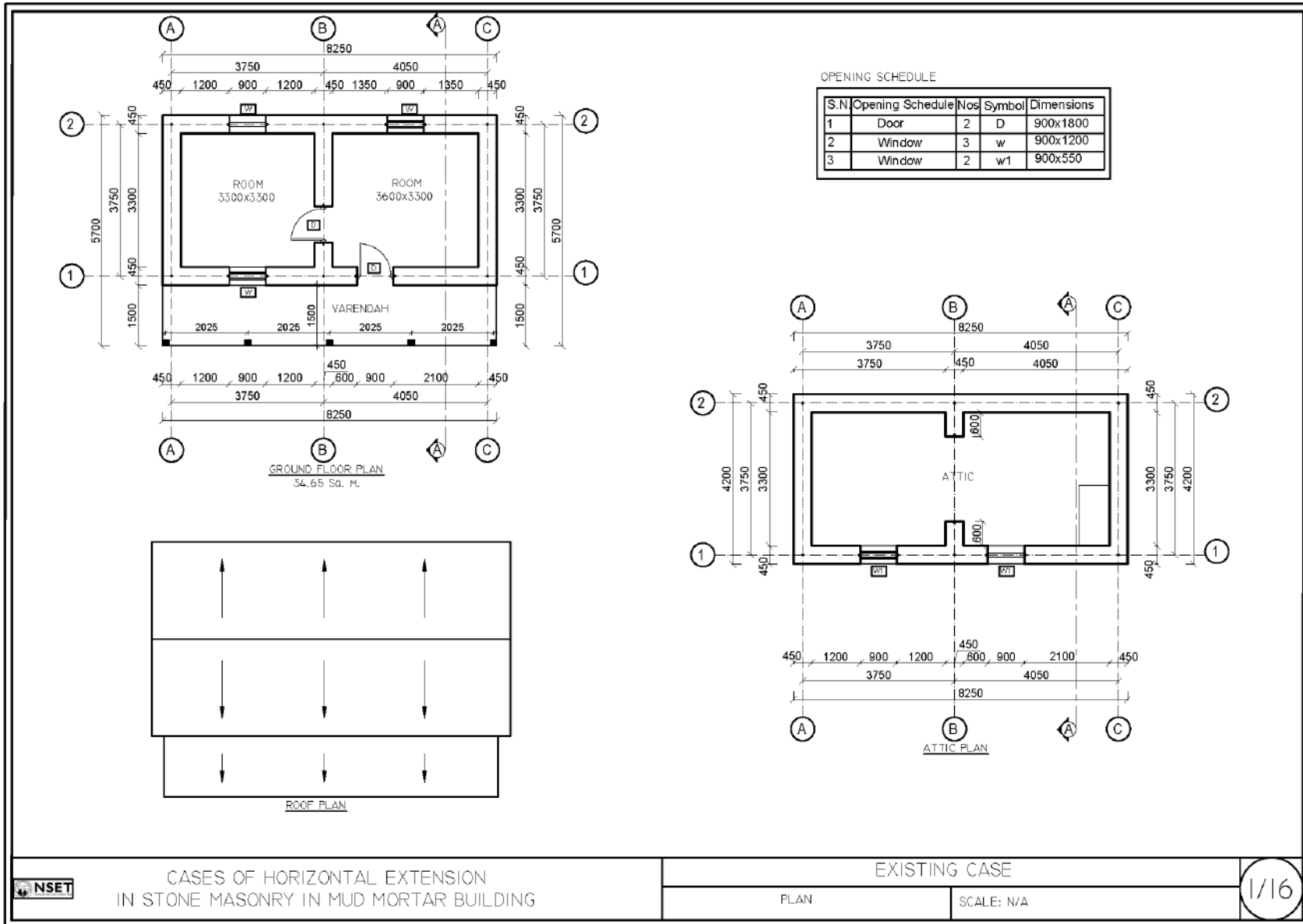

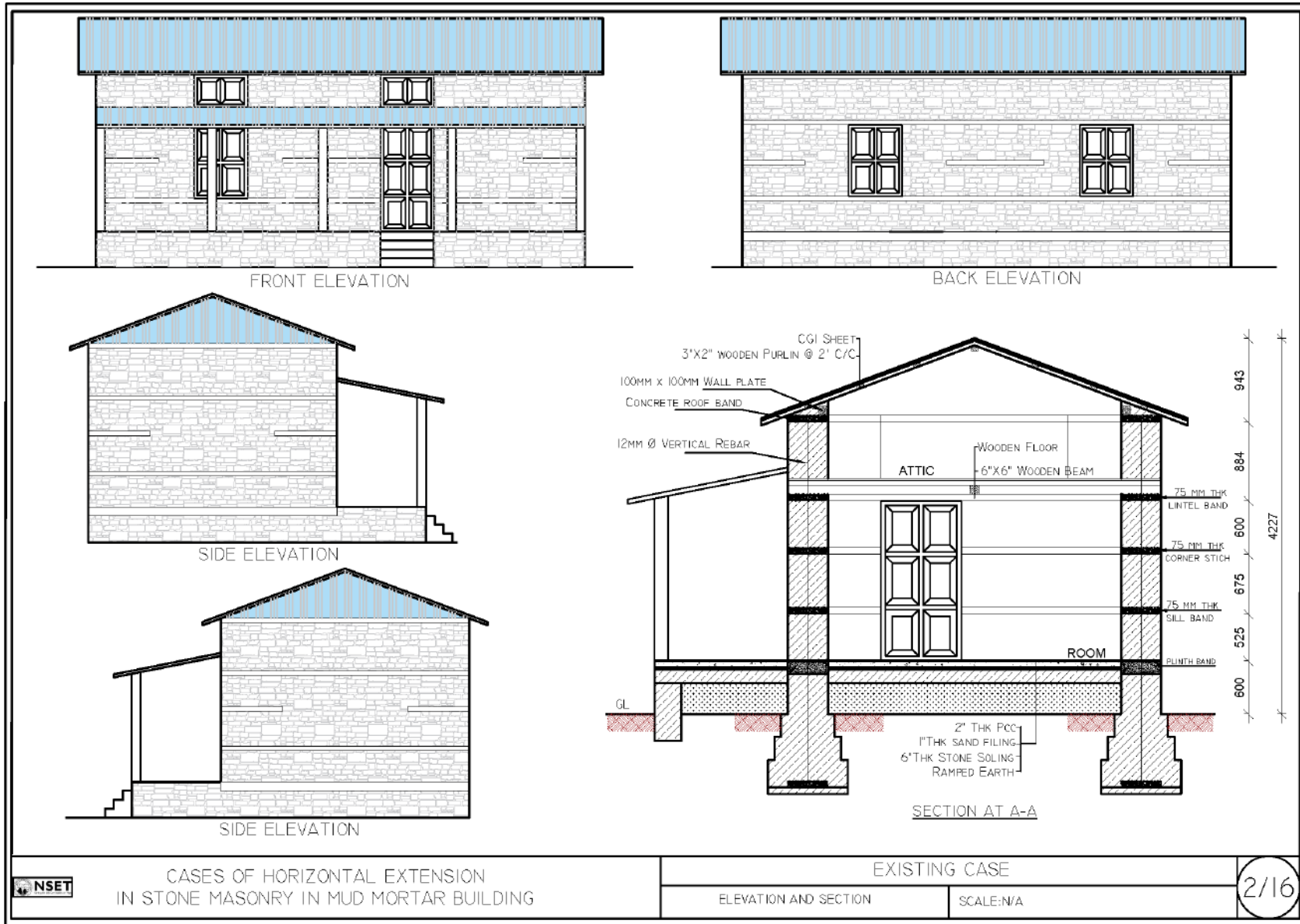

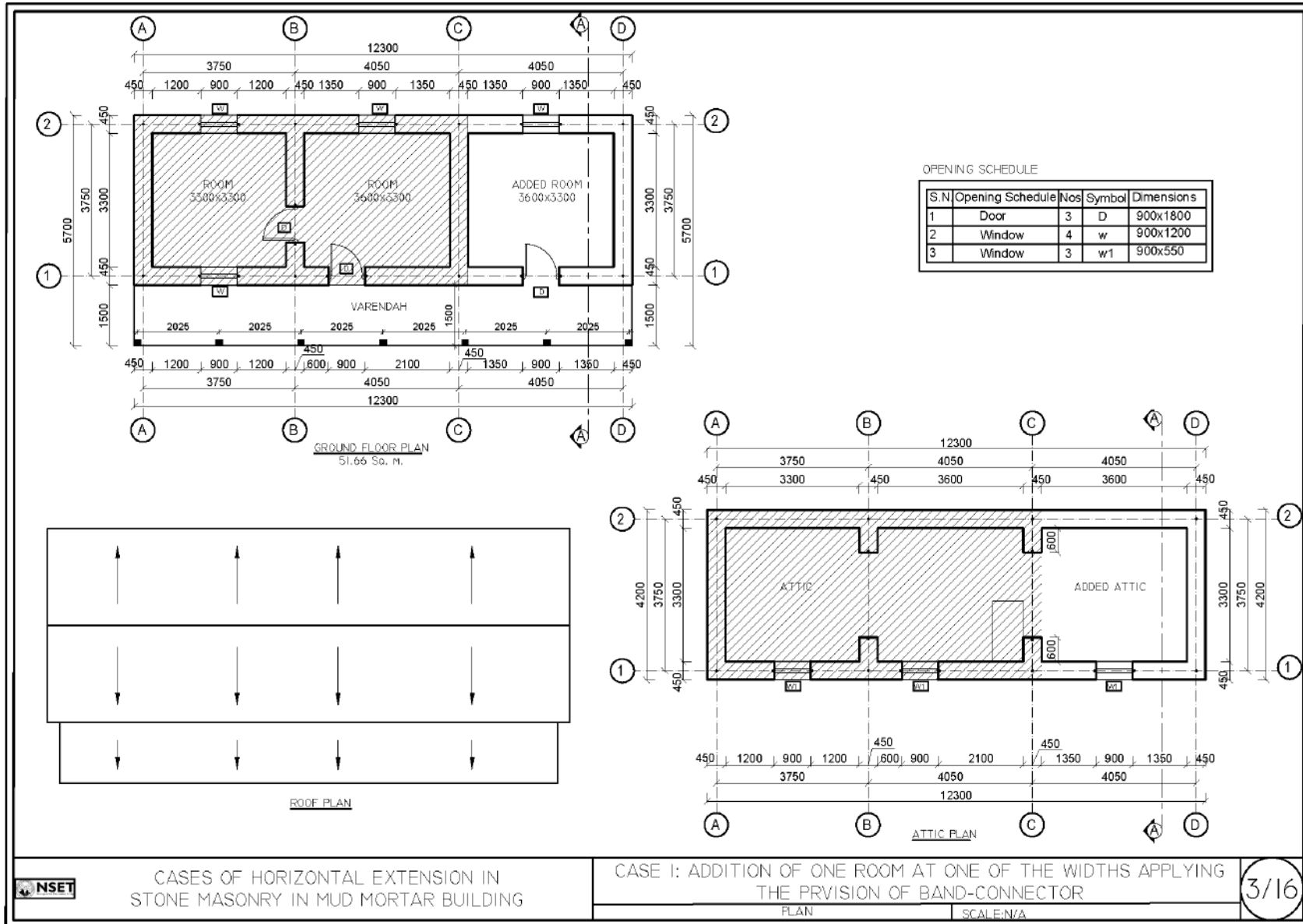



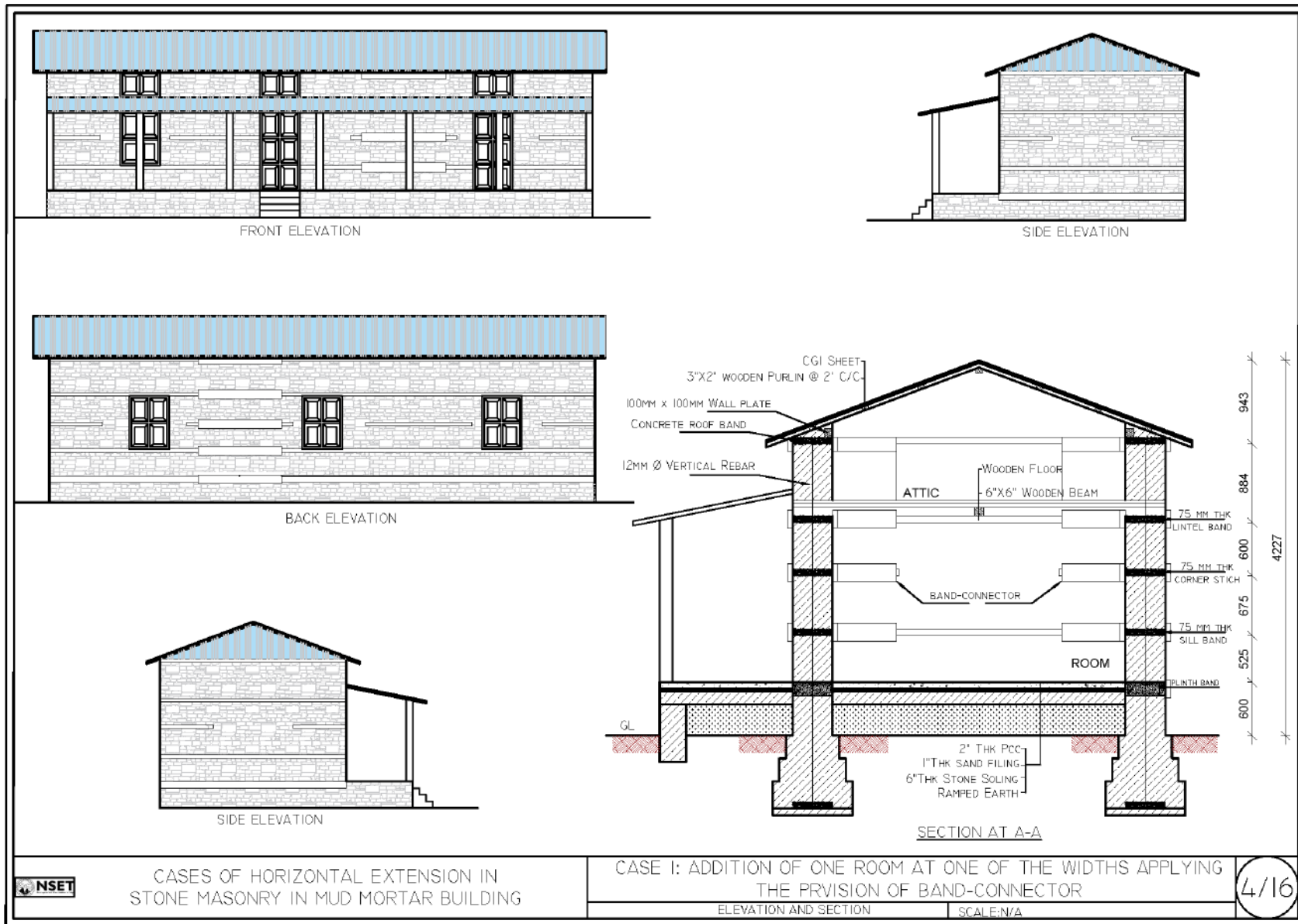

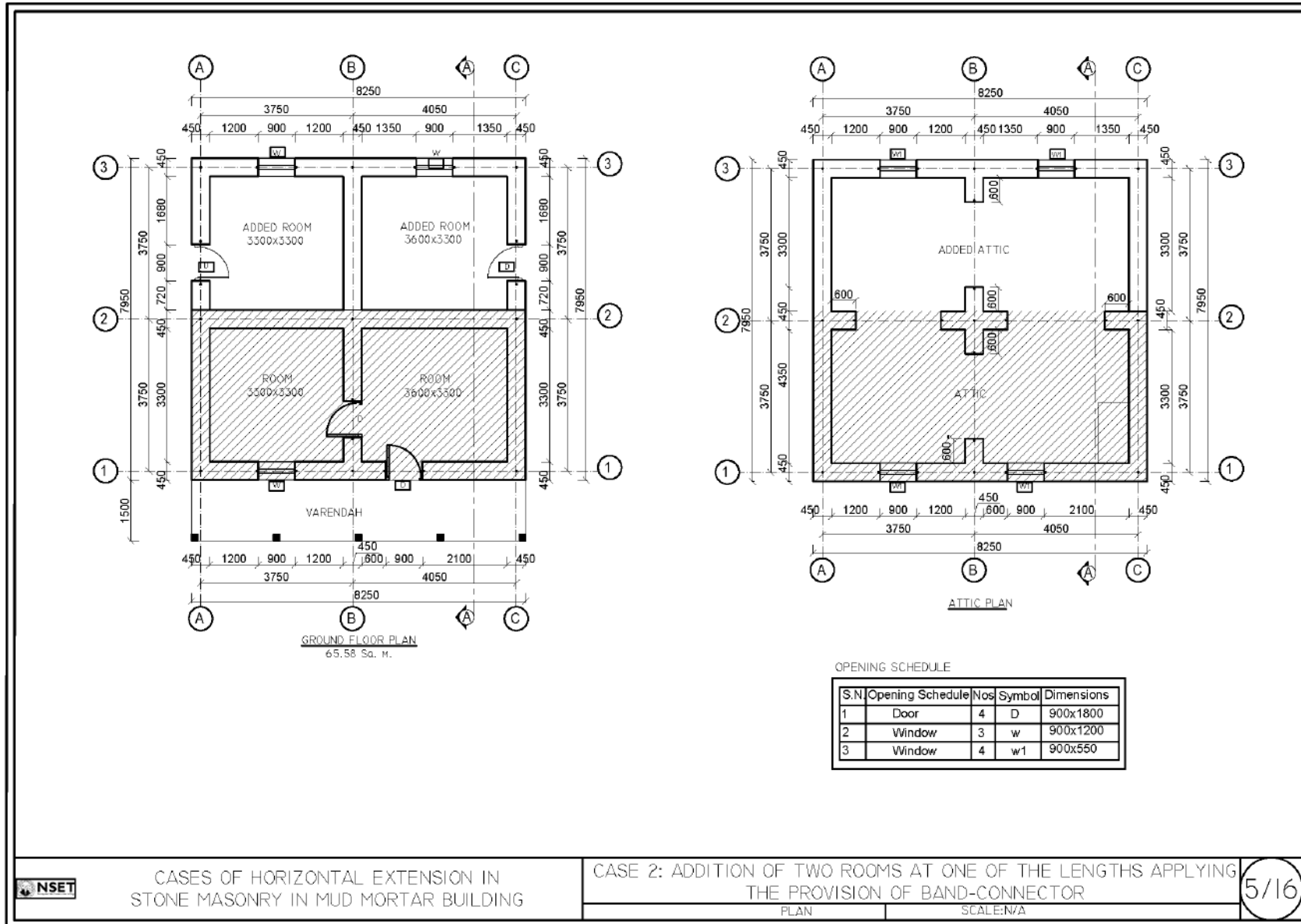

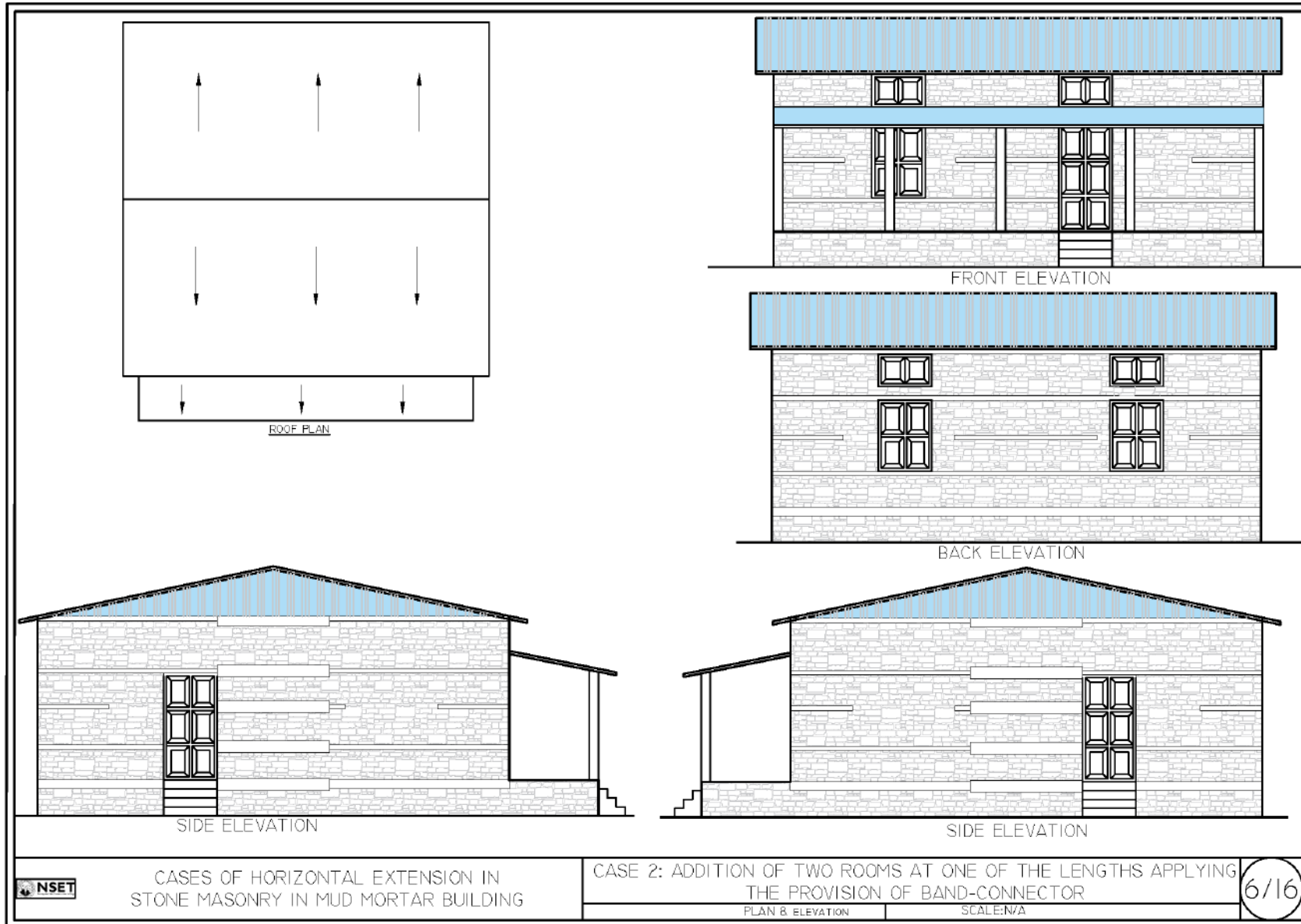

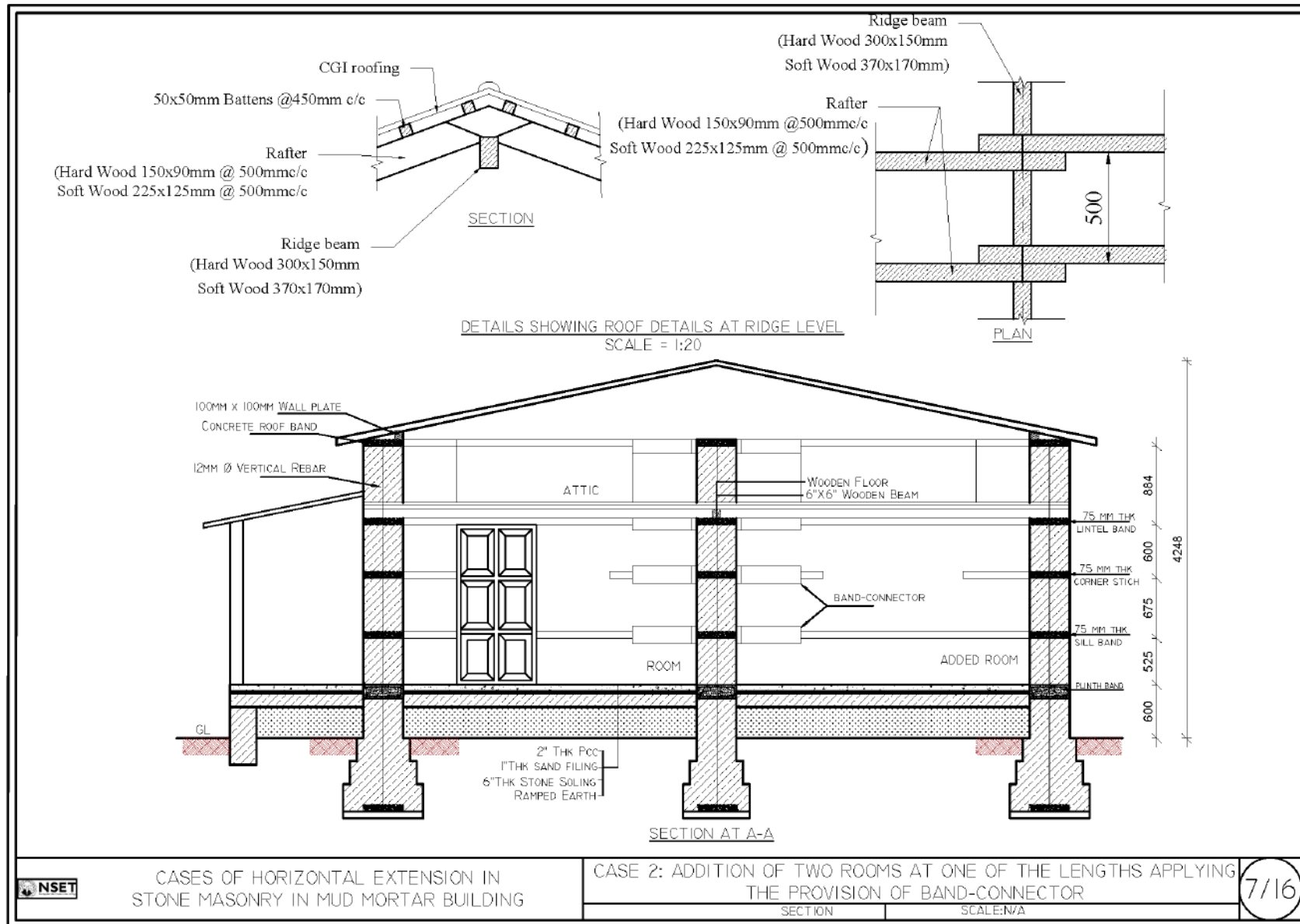

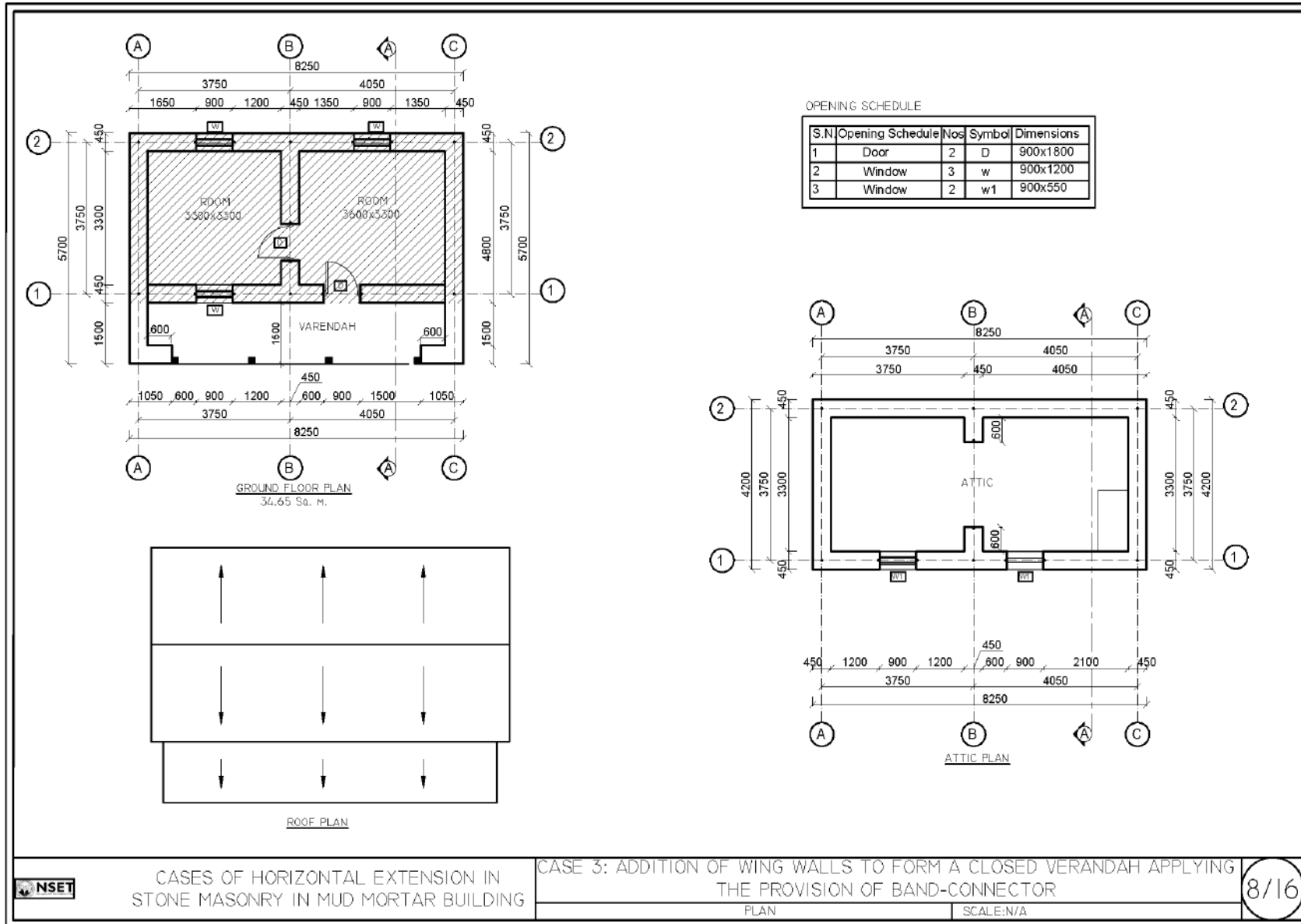

**NSET** CASES OF HORIZONTAL EXTENSION IN STONE MASONRY IN MUD MORTAR BUILDING

CASE 3: ADDITION OF WING WALLS TO FORM A CLOSED VERANDAH APPLYING THE PROVISION OF BAND-CONNECTOR  
PLAN SCALE: N/A

8/16

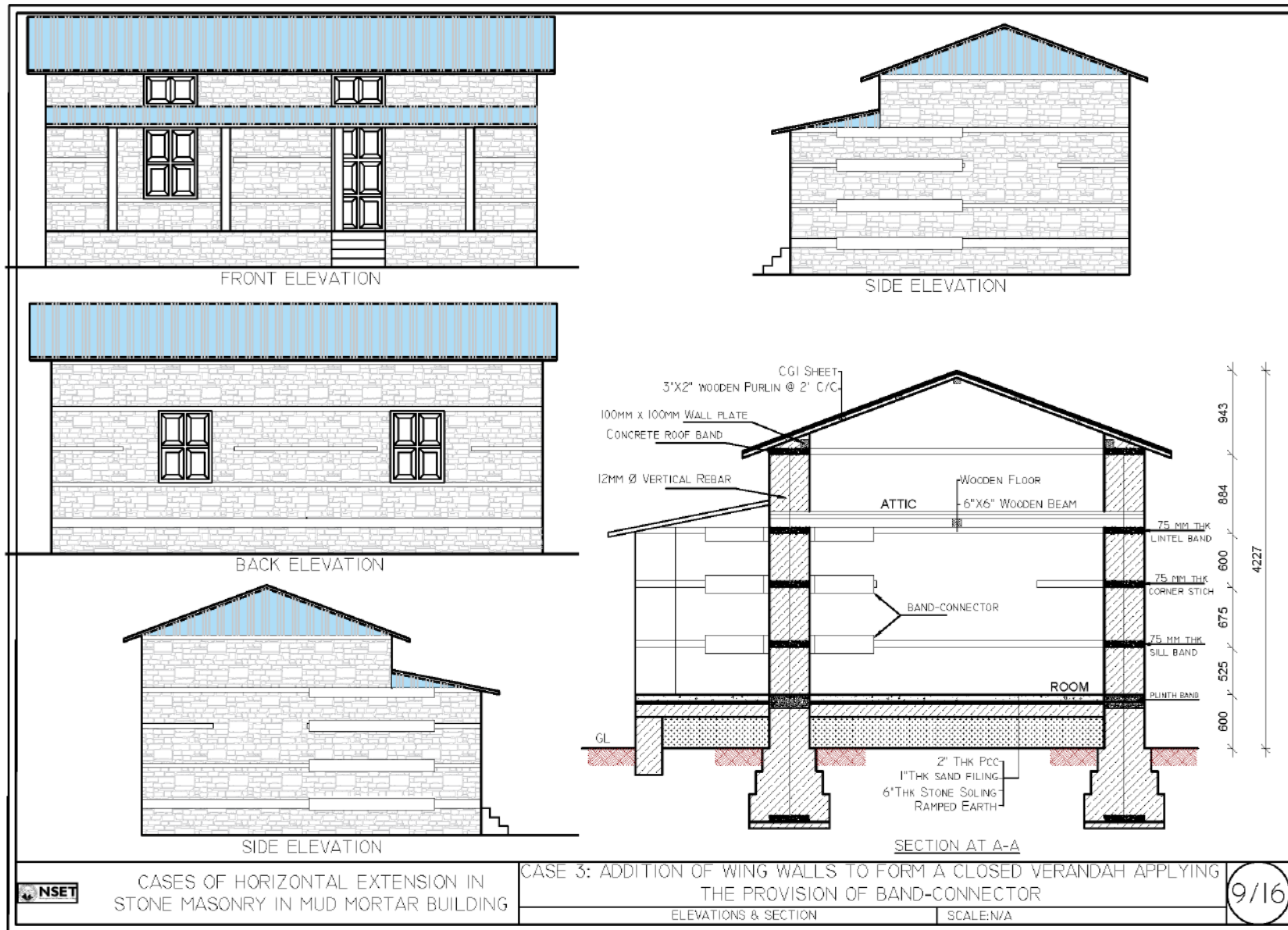

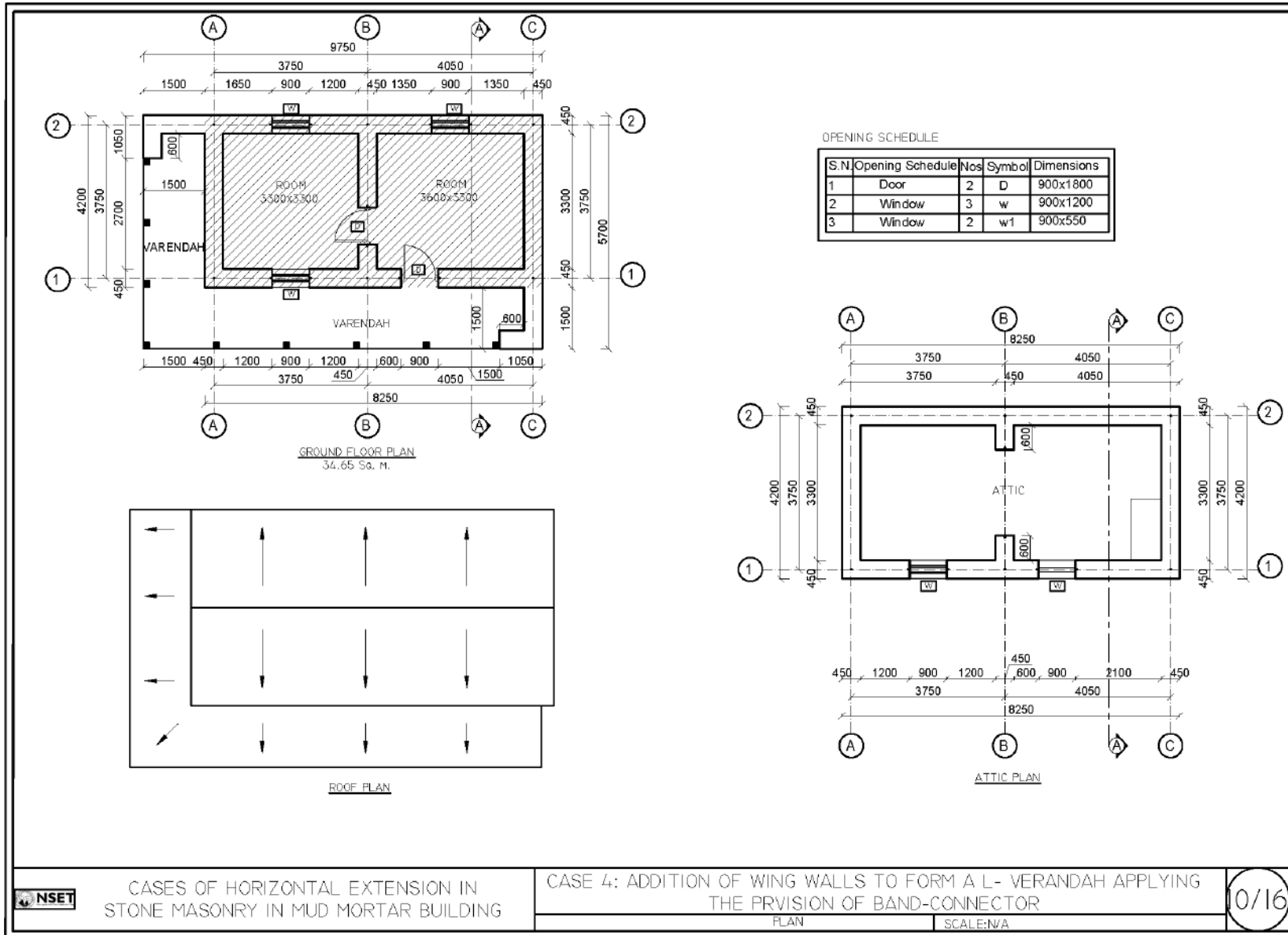

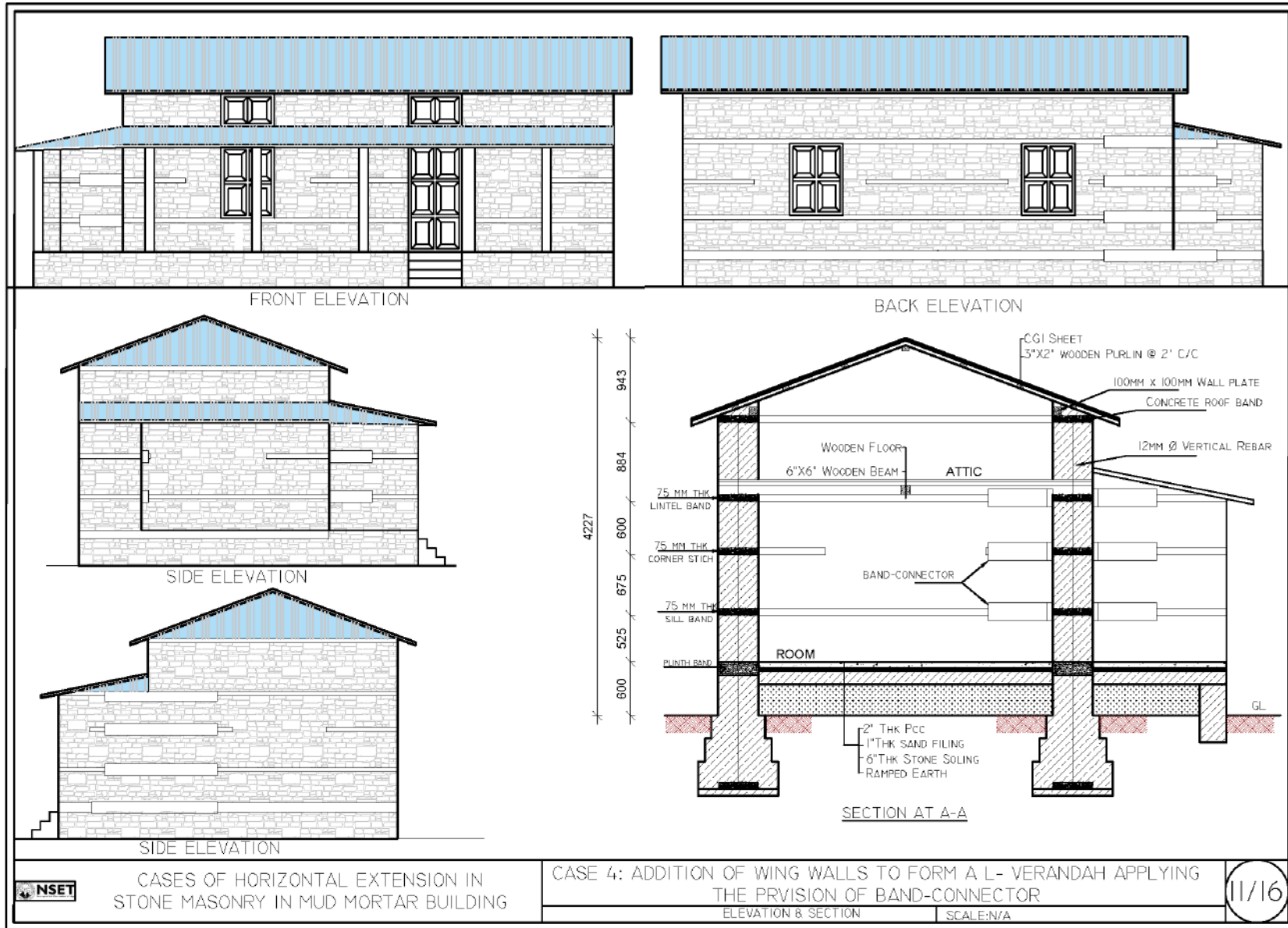



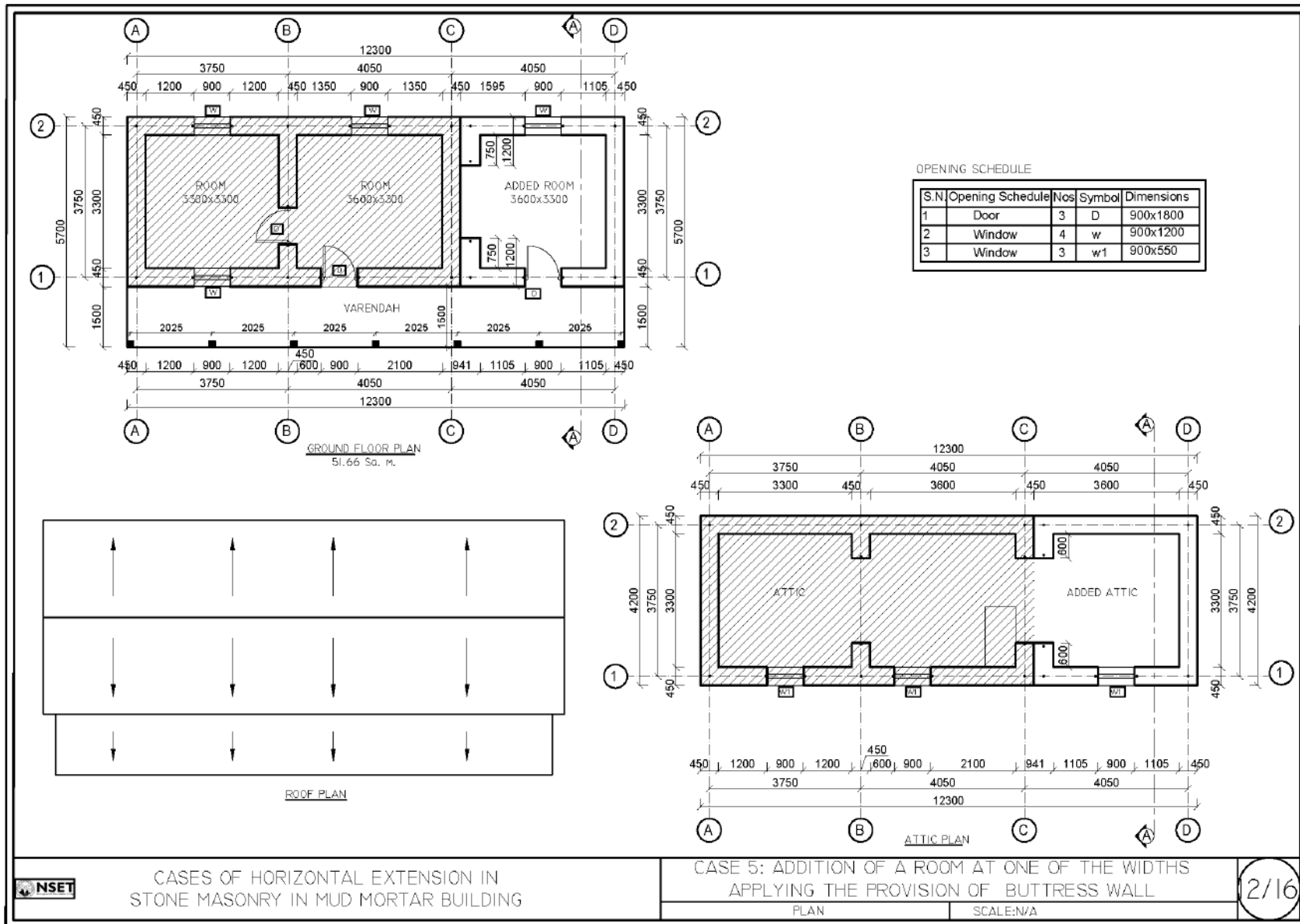

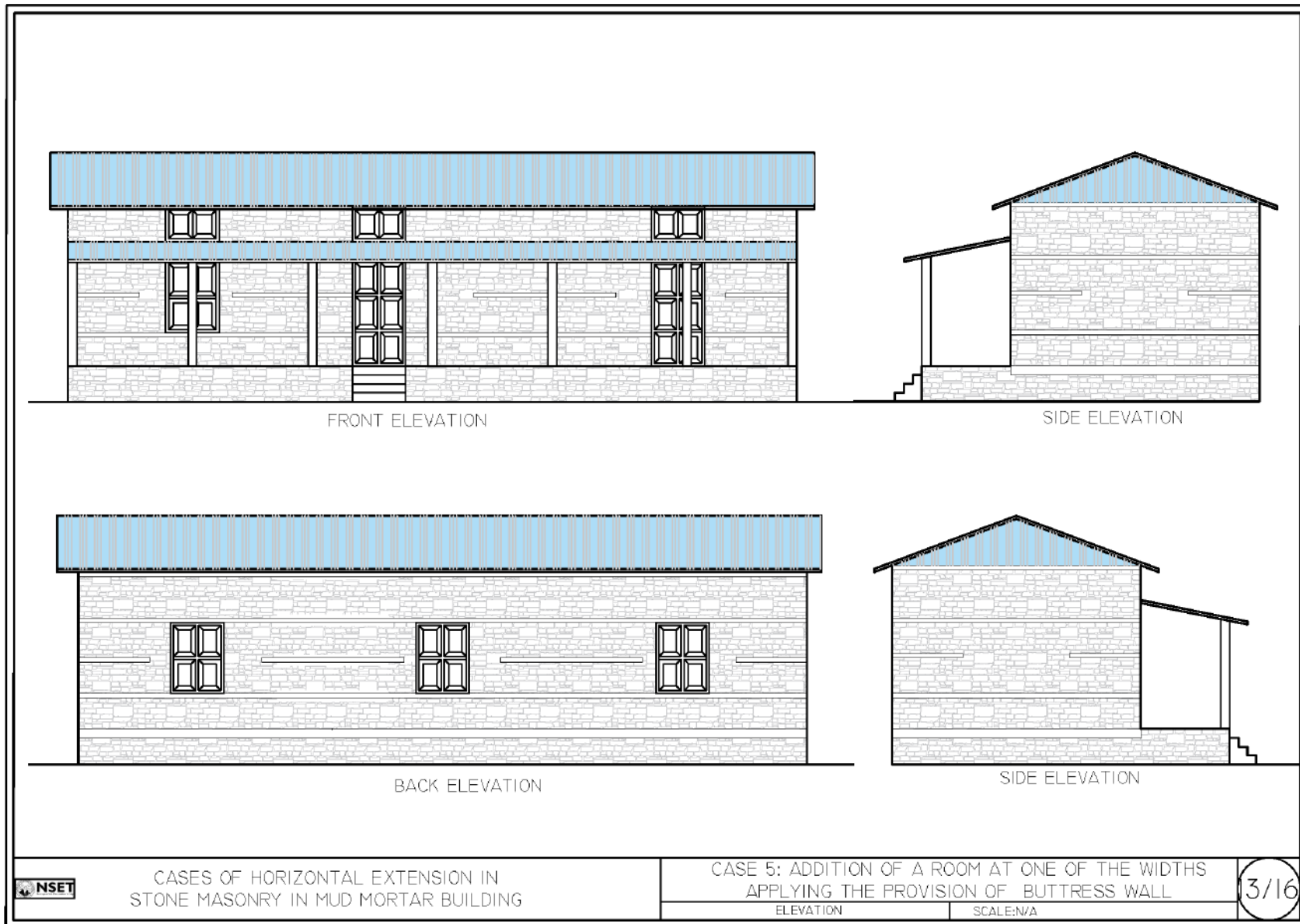

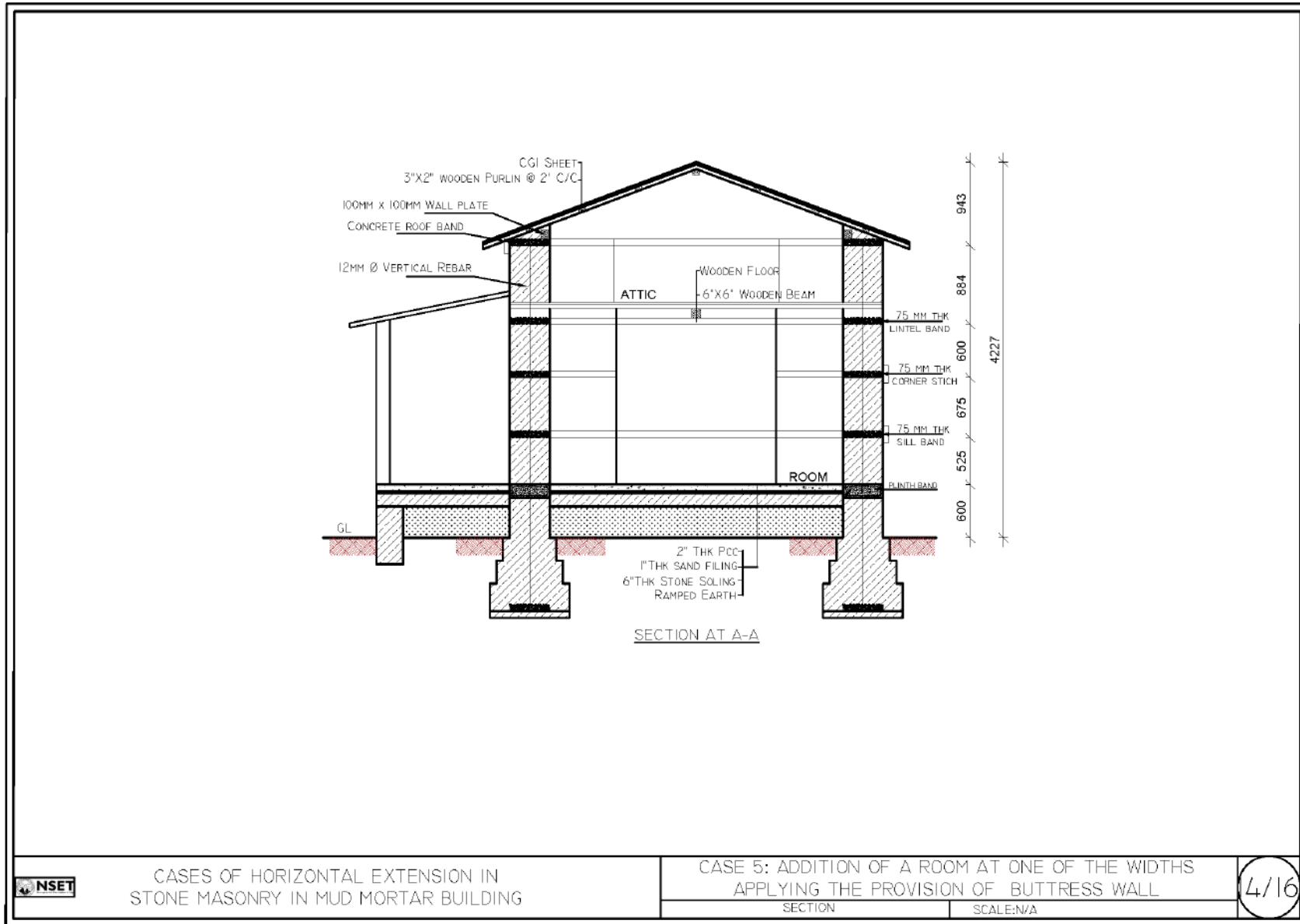

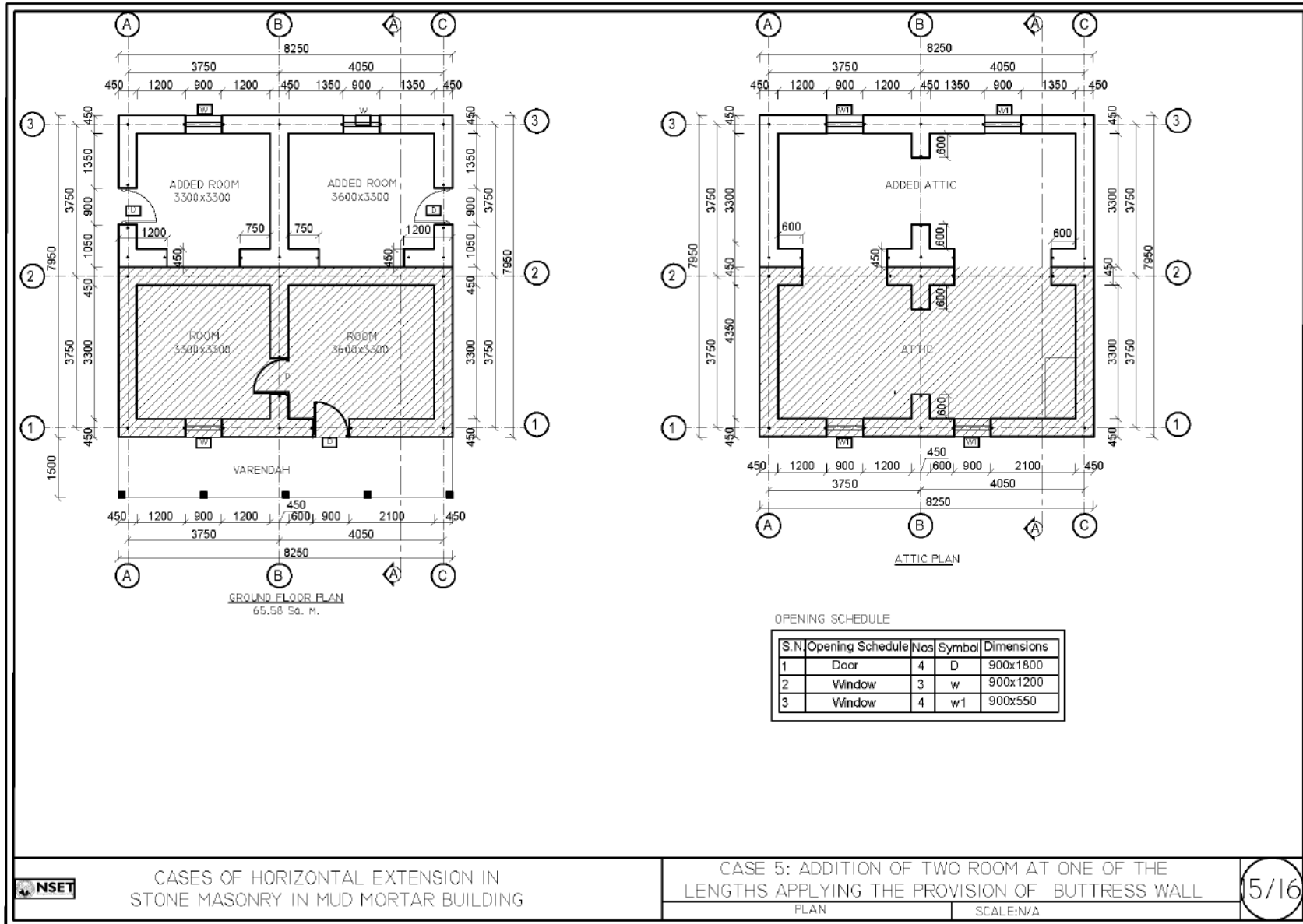

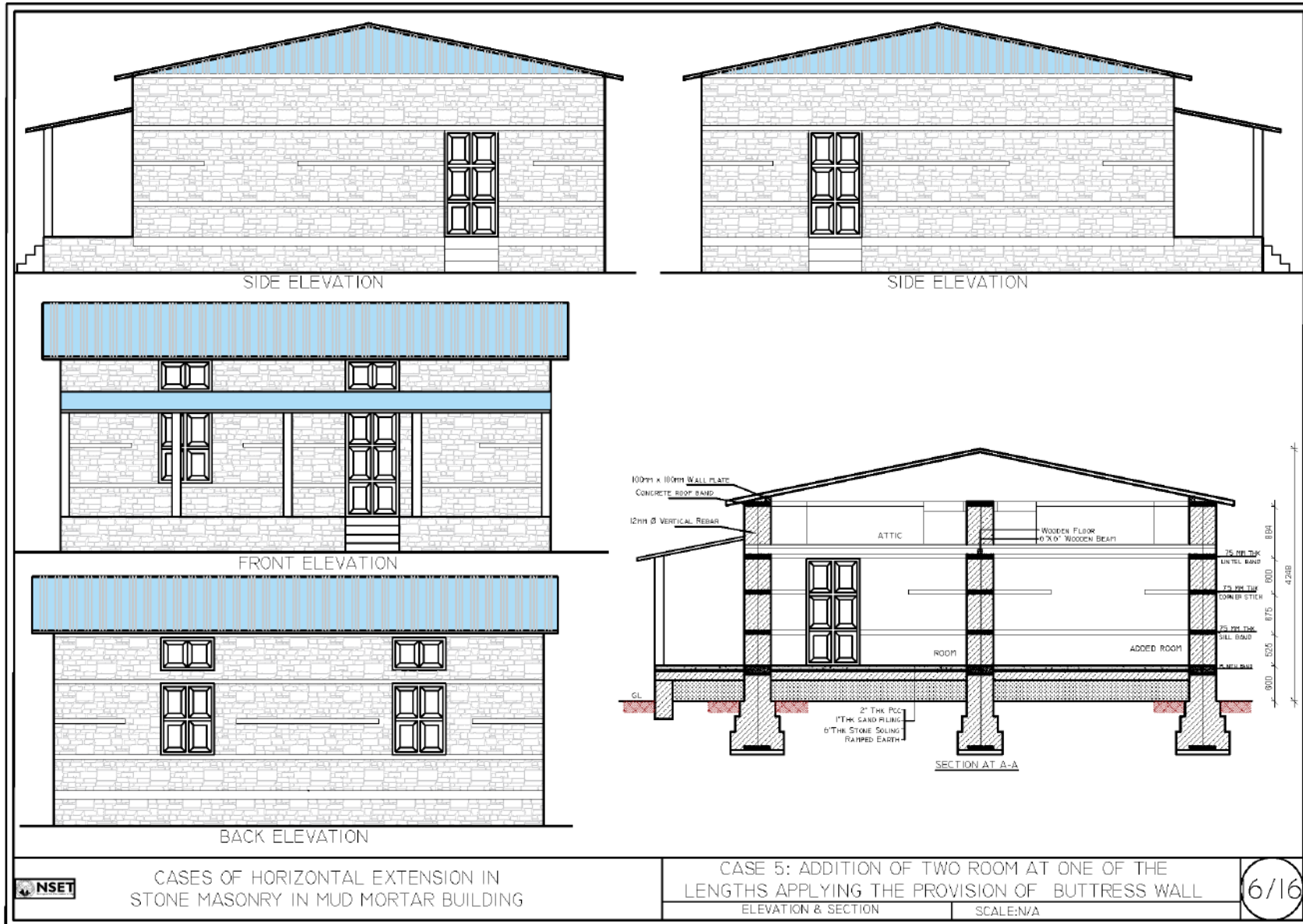

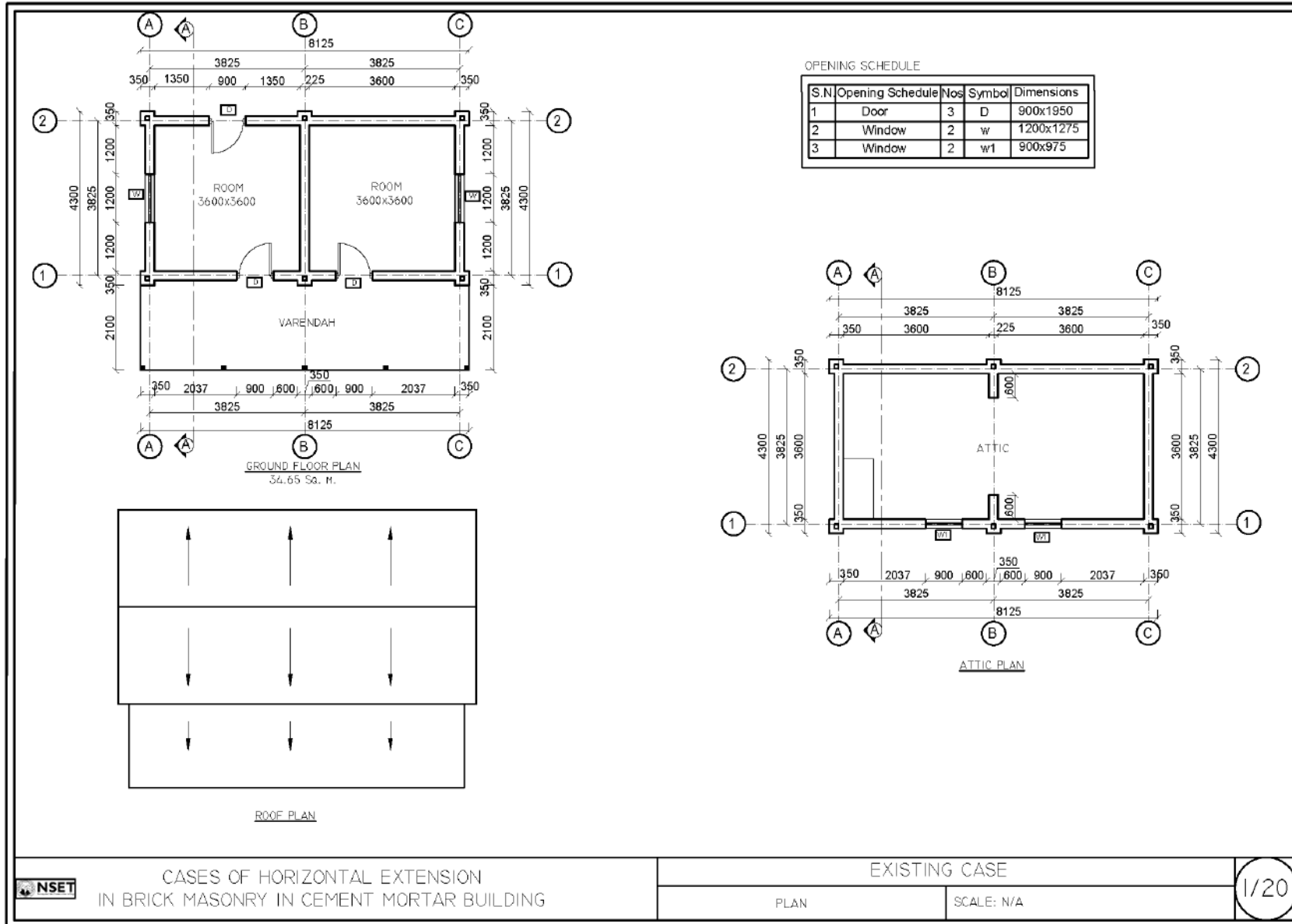

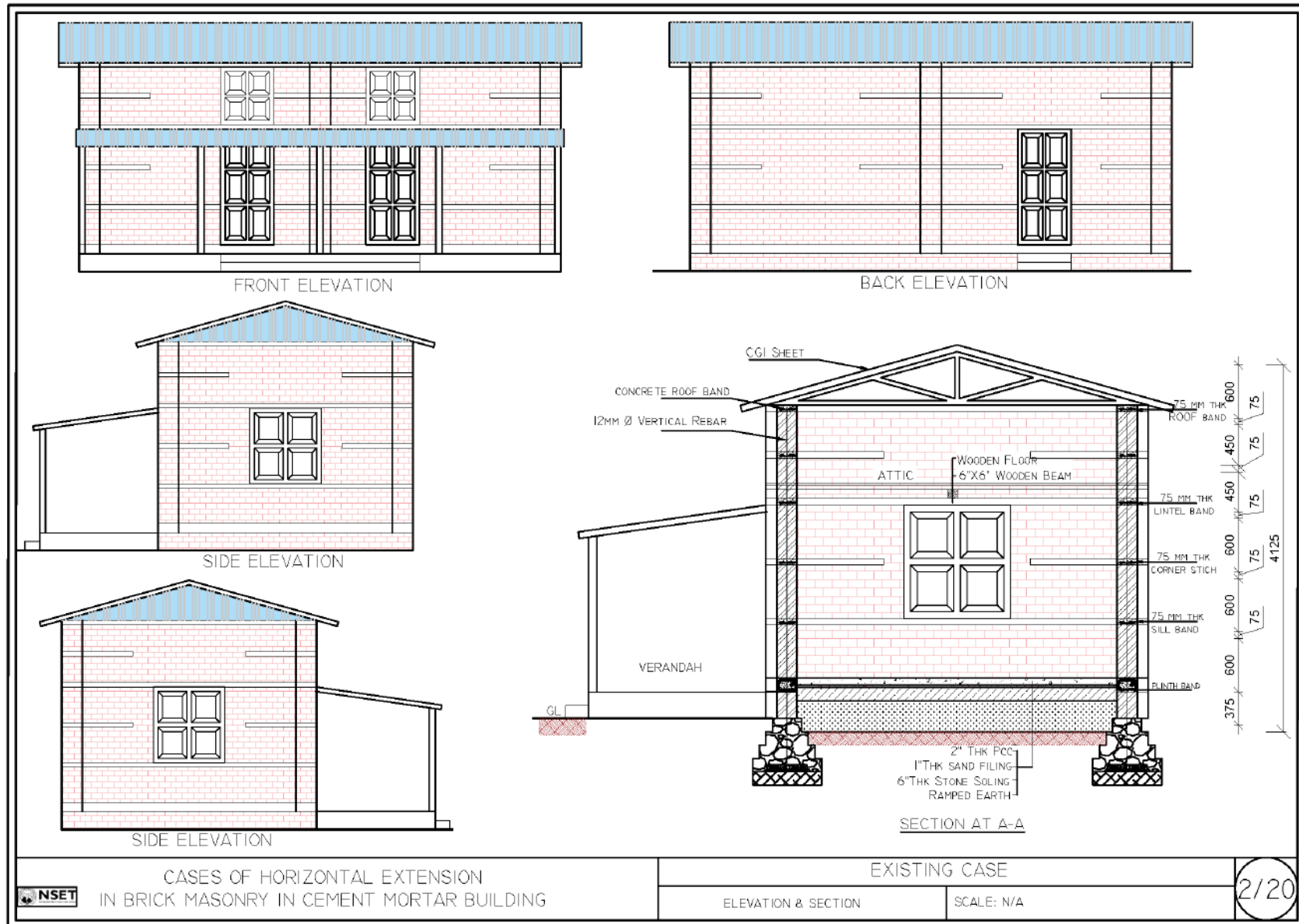

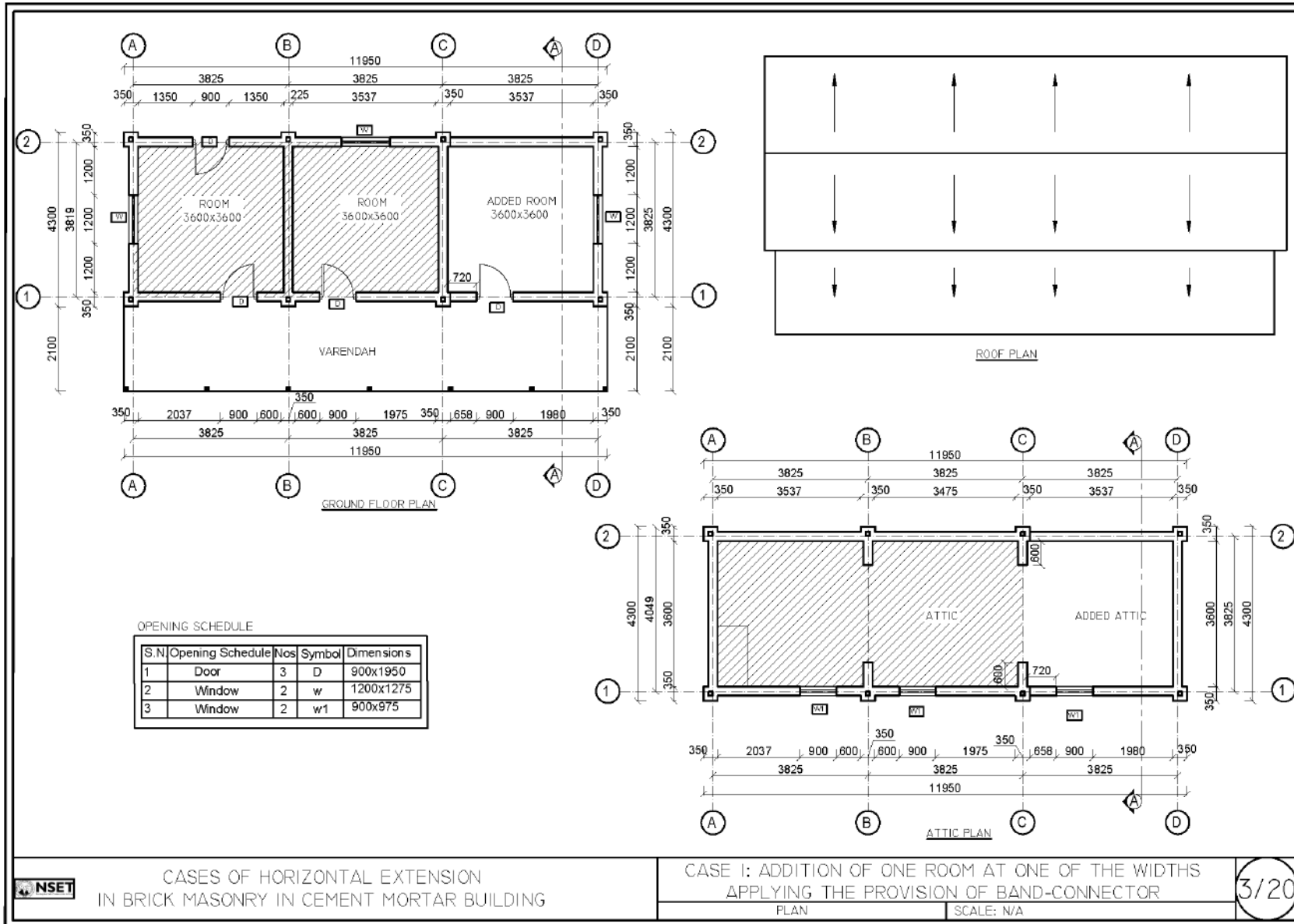



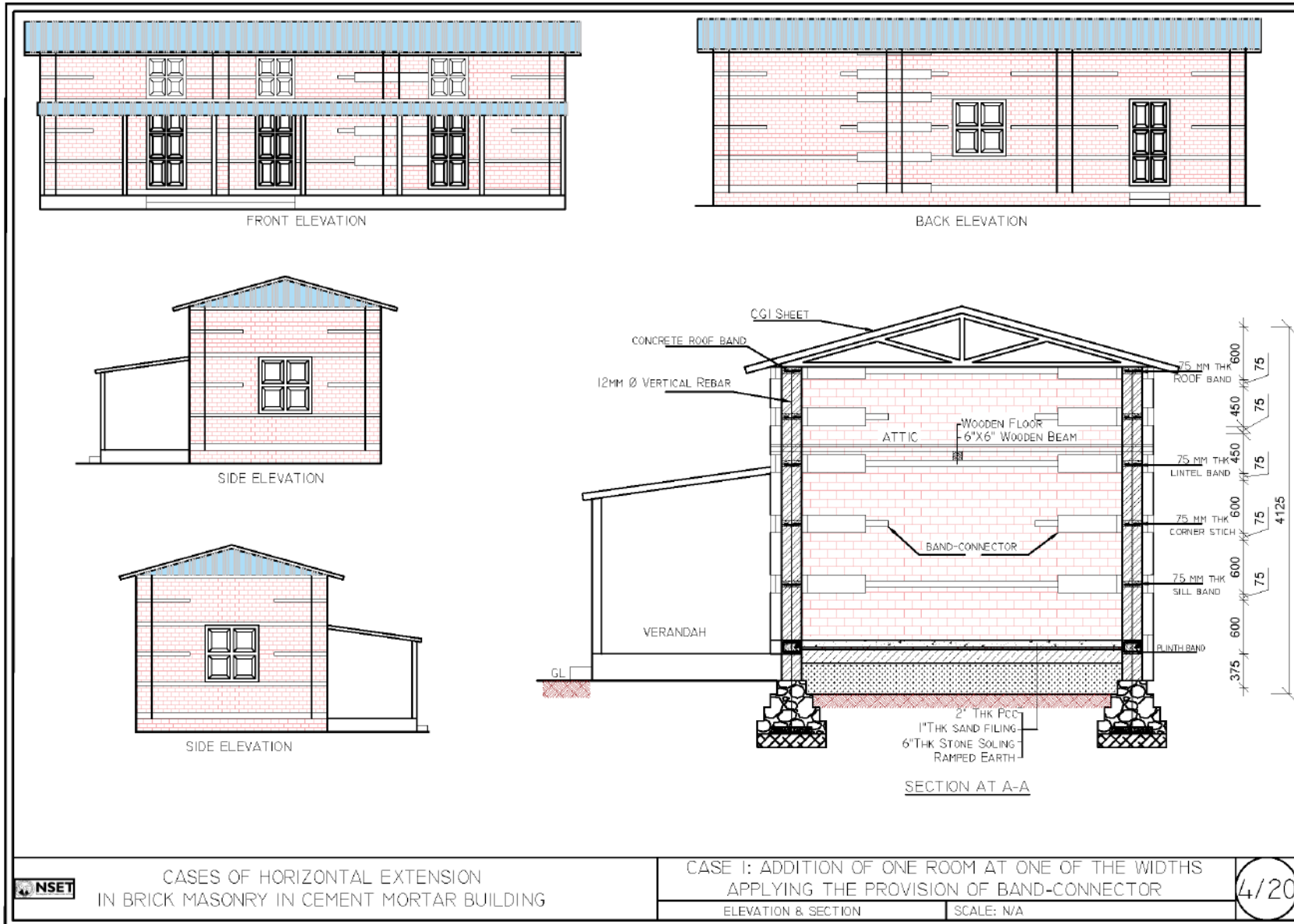

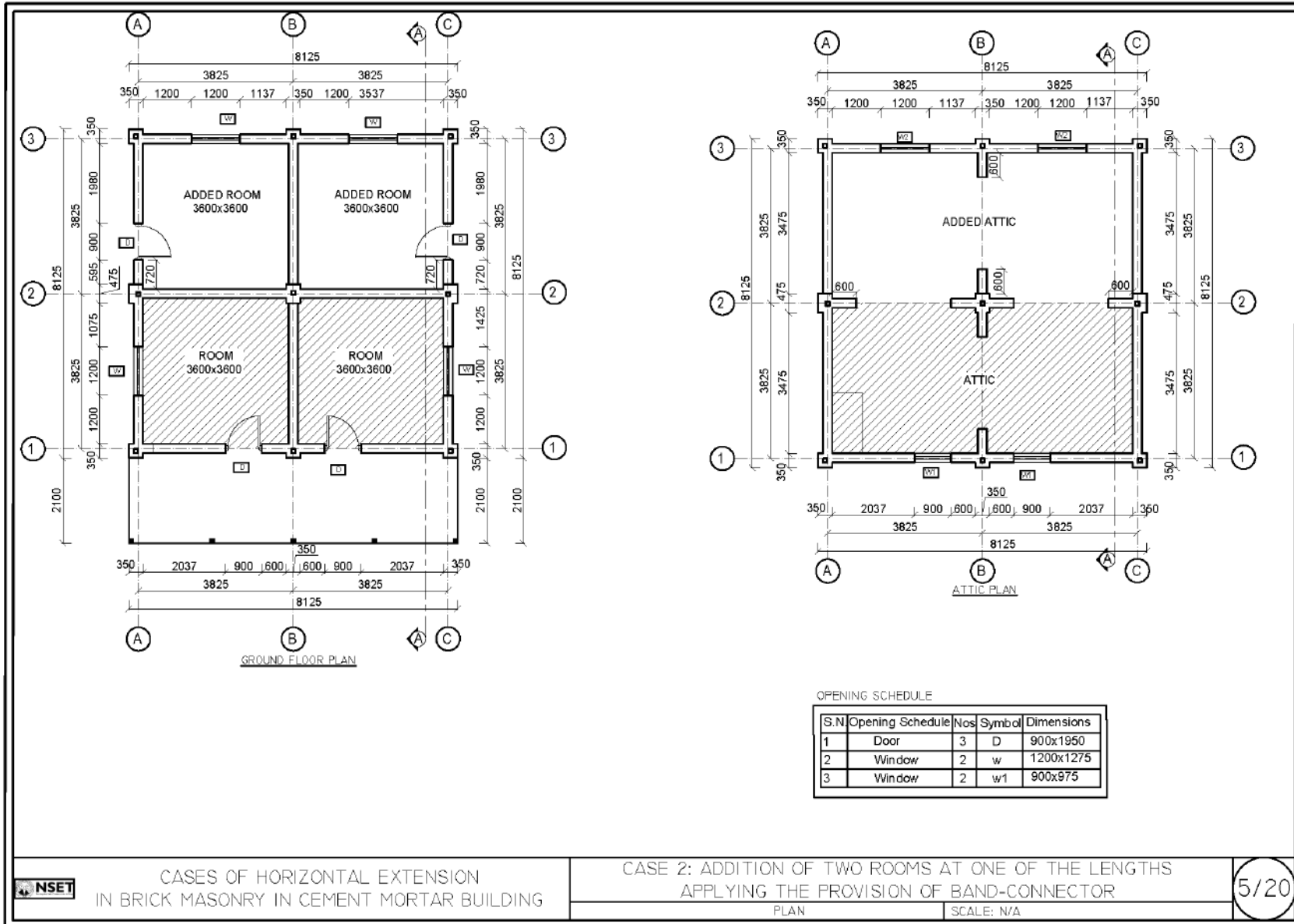

CASES OF HORIZONTAL EXTENSION  
IN BRICK MASONRY IN CEMENT MORTAR BUILDING

CASE 2: ADDITION OF TWO ROOMS AT ONE OF THE LENGTHS  
APPLYING THE PROVISION OF BAND-CONNECTOR

PLAN SCALE: N/A

5/20

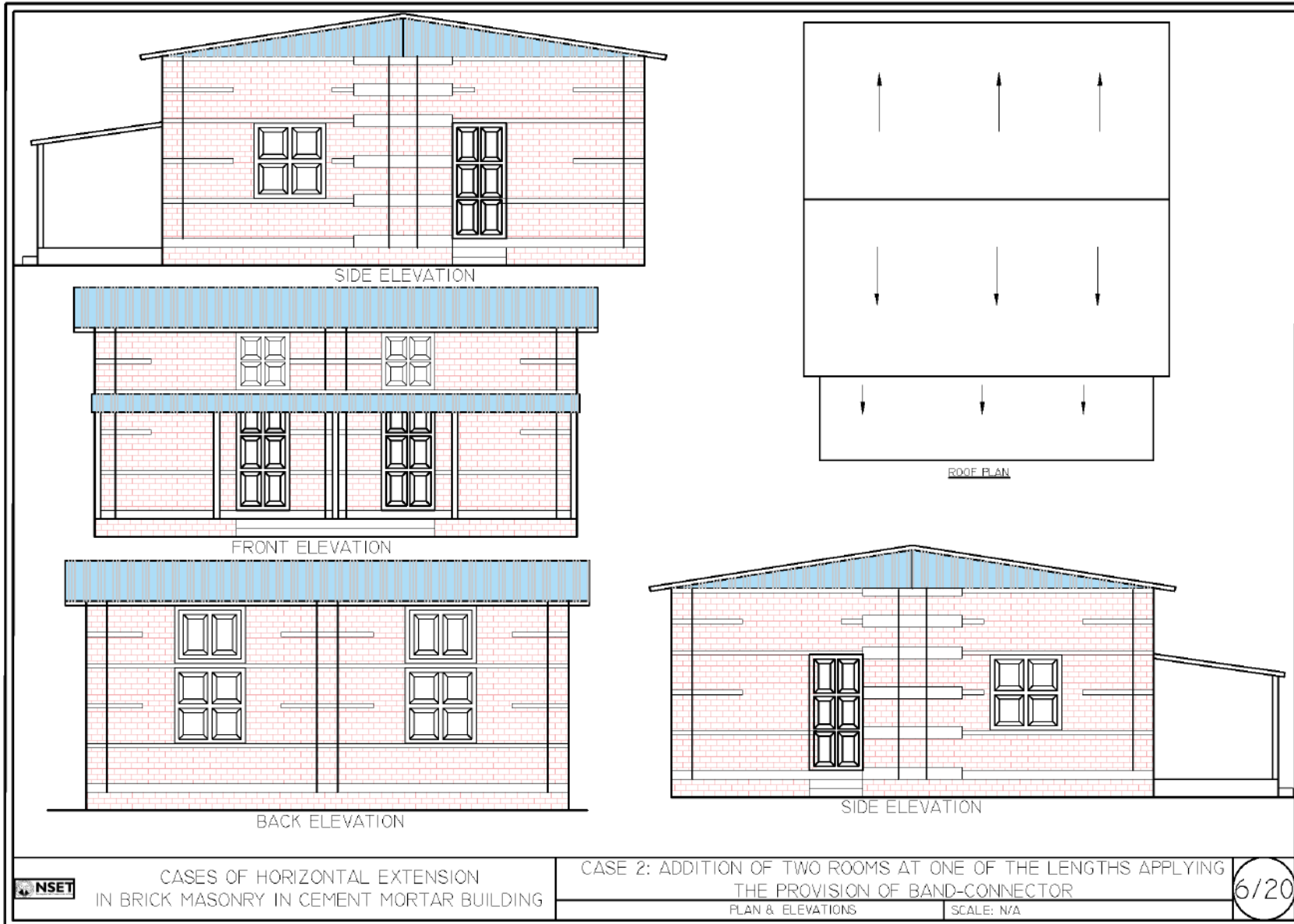

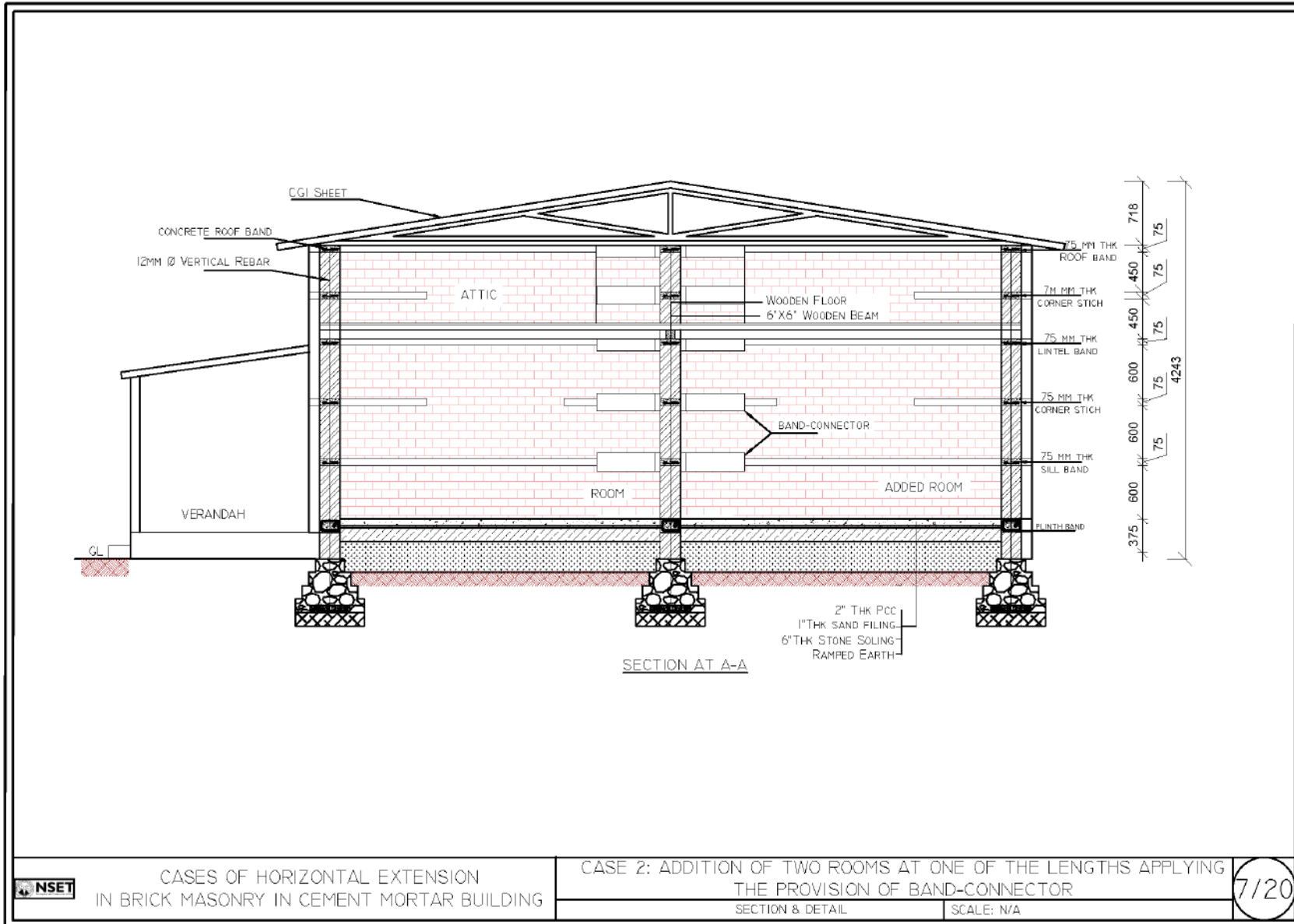

CASES OF HORIZONTAL EXTENSION  
IN BRICK MASONRY IN CEMENT MORTAR BUILDING

CASE 2: ADDITION OF TWO ROOMS AT ONE OF THE LENGTHS APPLYING  
THE PROVISION OF BAND-CONNECTOR  
SECTION & DETAIL SCALE: N/A

7/20

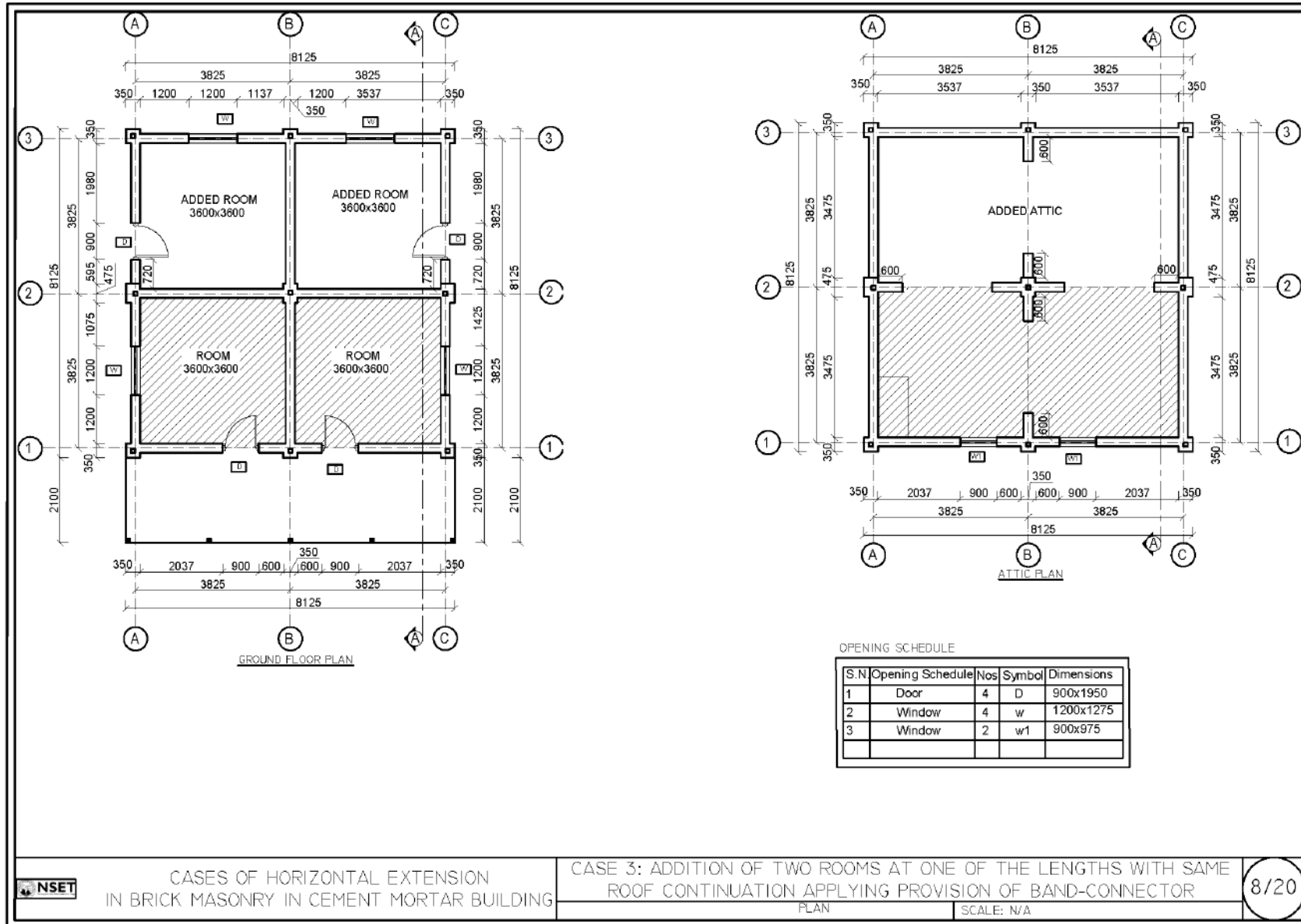

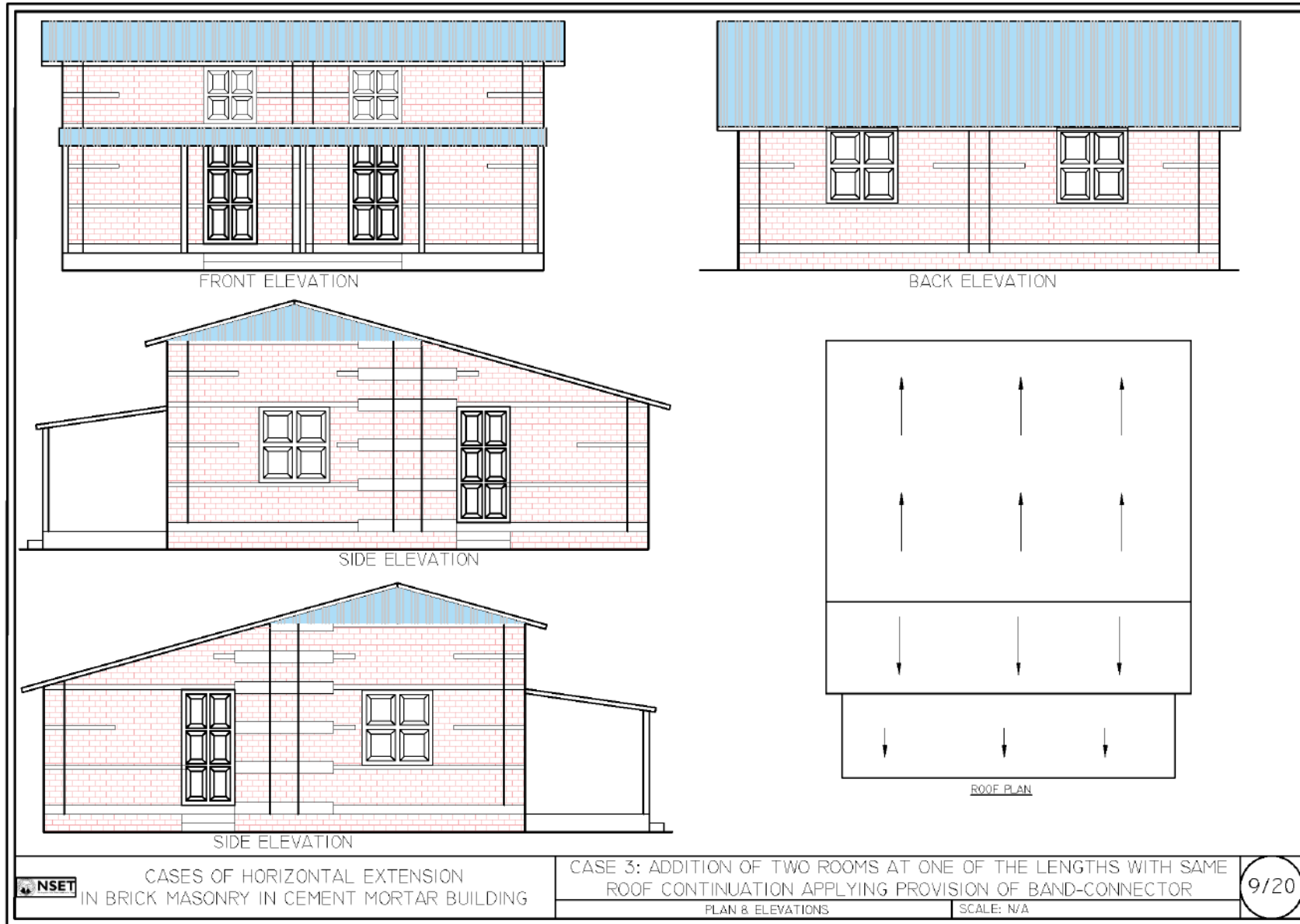

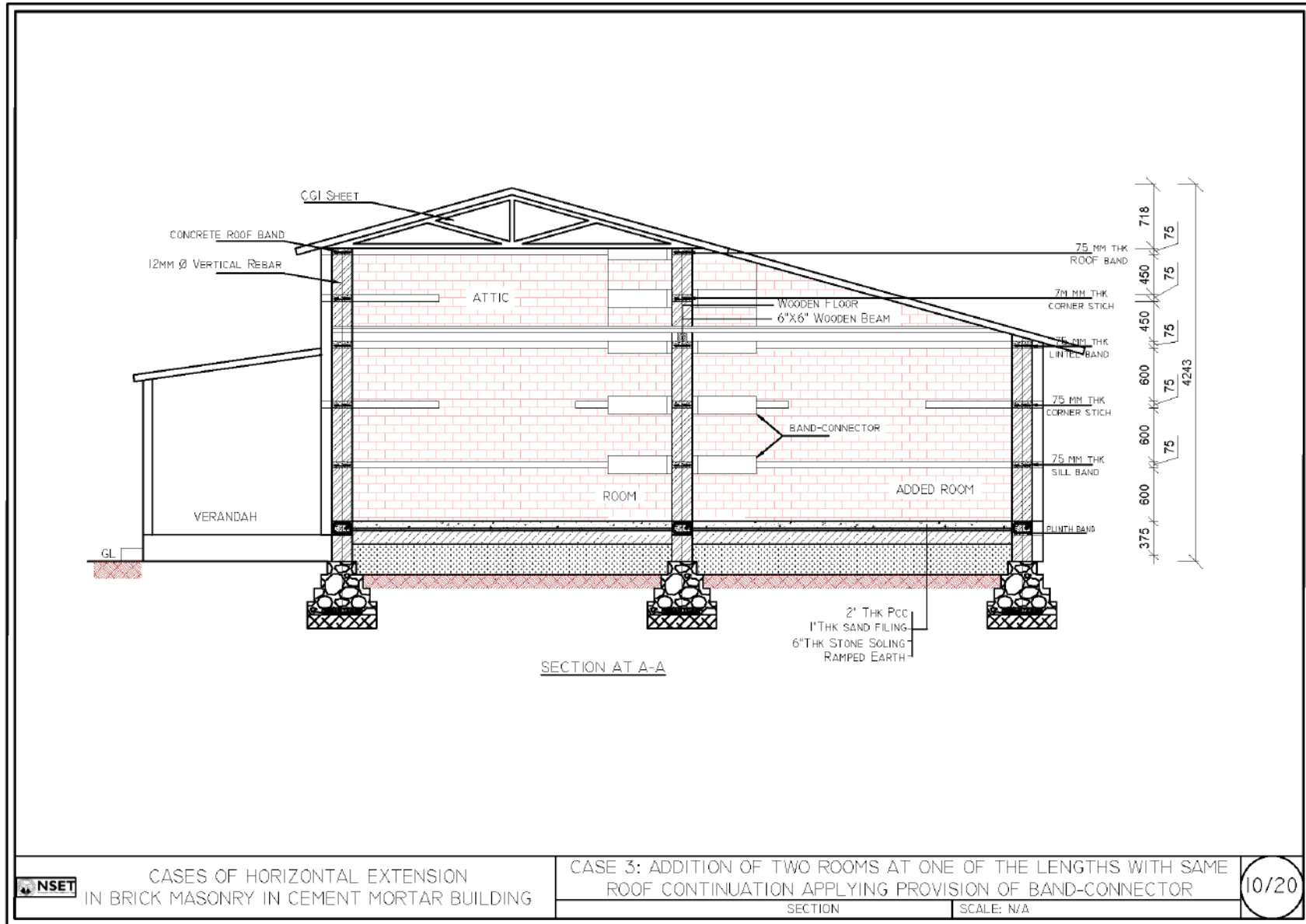

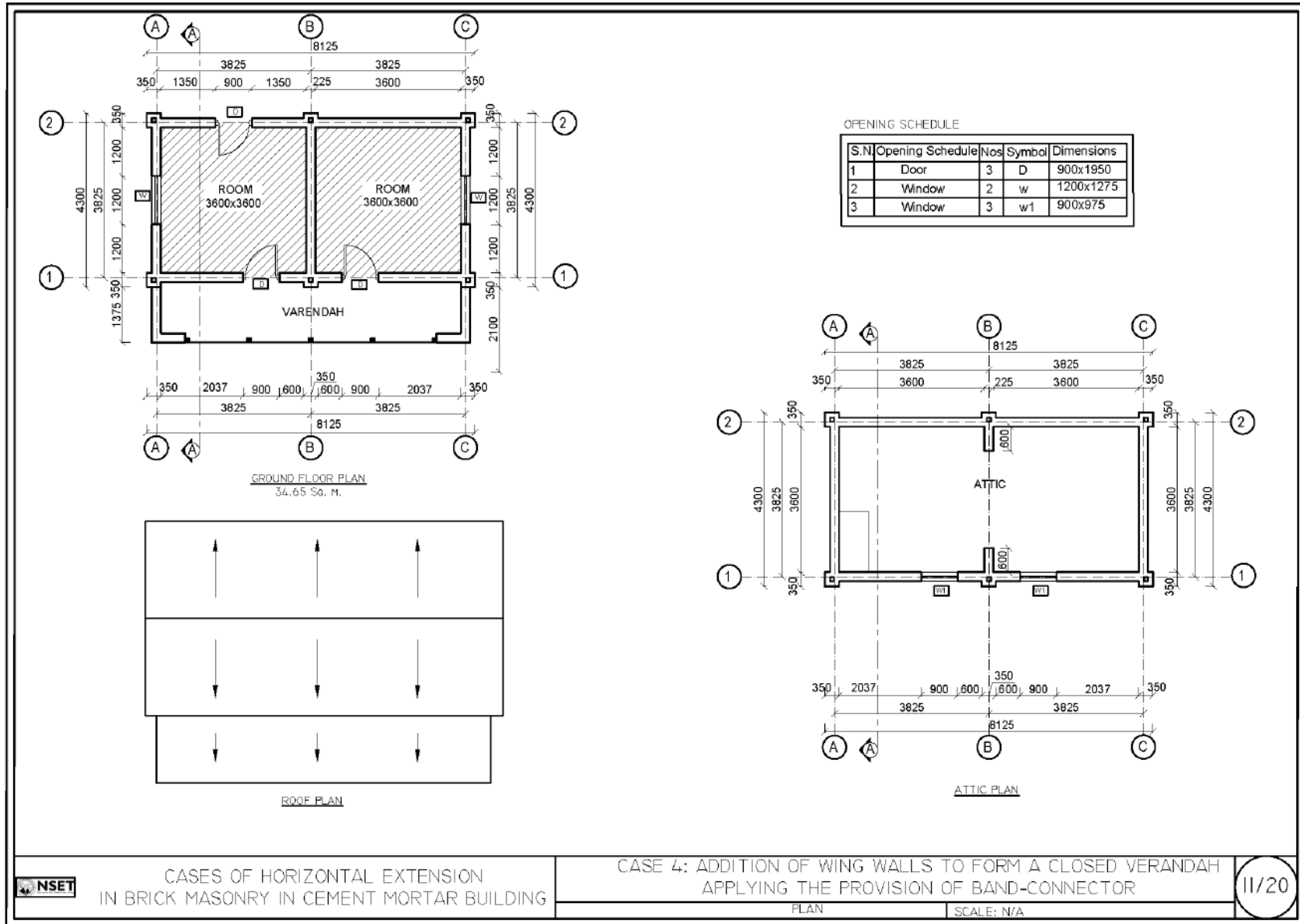

**NSET** CASES OF HORIZONTAL EXTENSION IN BRICK MASONRY IN CEMENT MORTAR BUILDING

CASE 4: ADDITION OF WING WALLS TO FORM A CLOSED VERANDAH APPLYING THE PROVISION OF BAND-CONNECTOR

PLAN SCALE: N/A

11/20



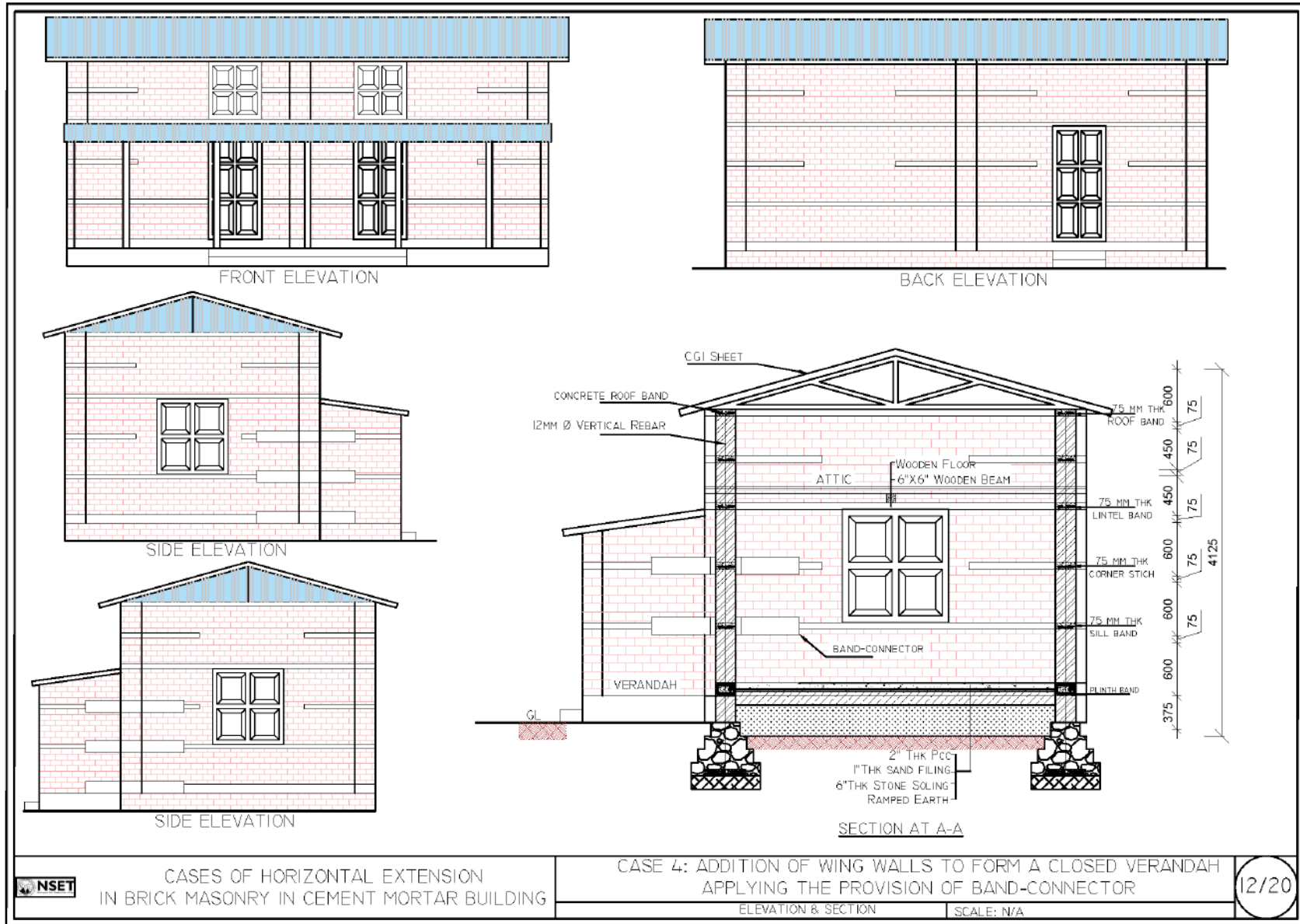

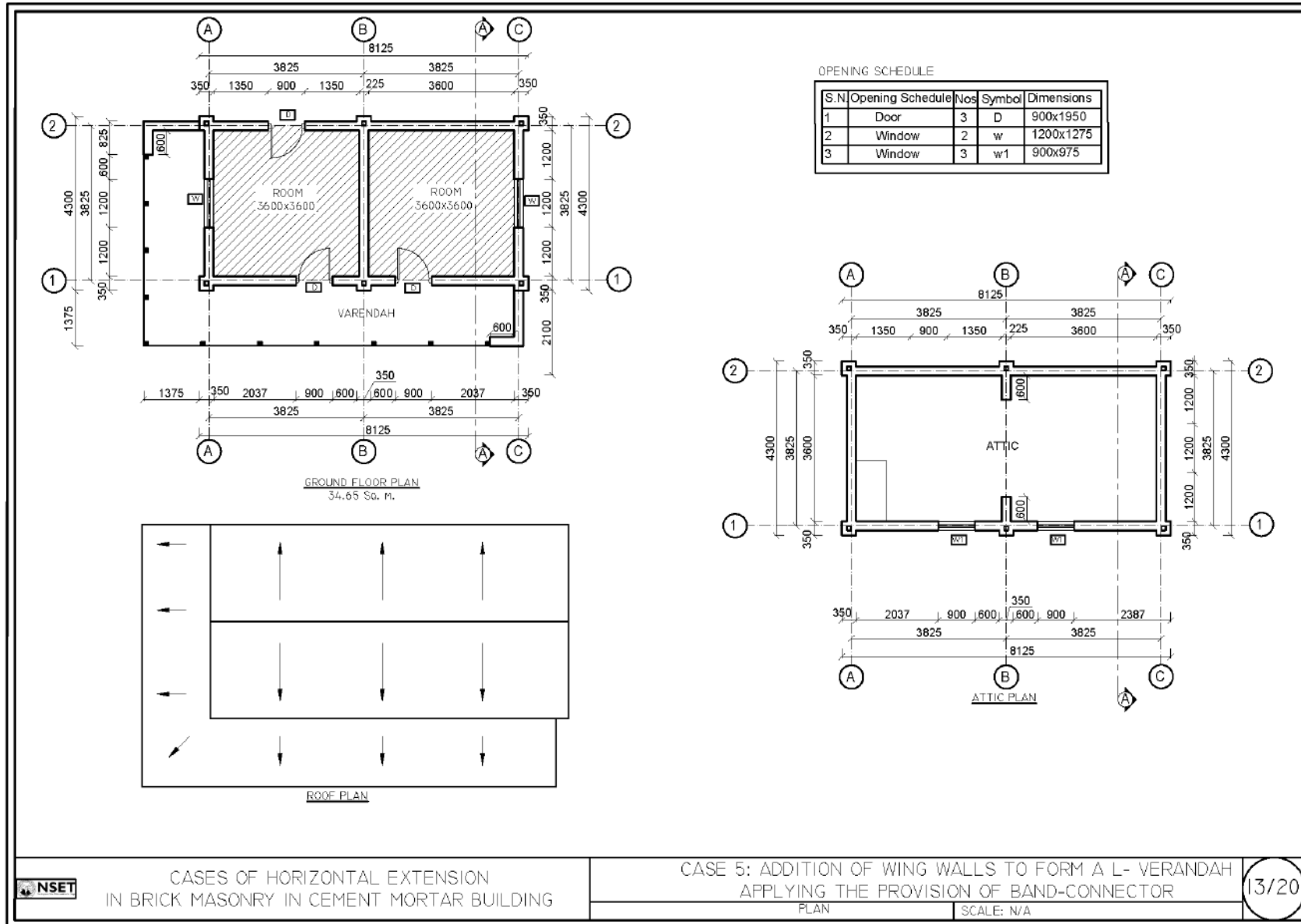

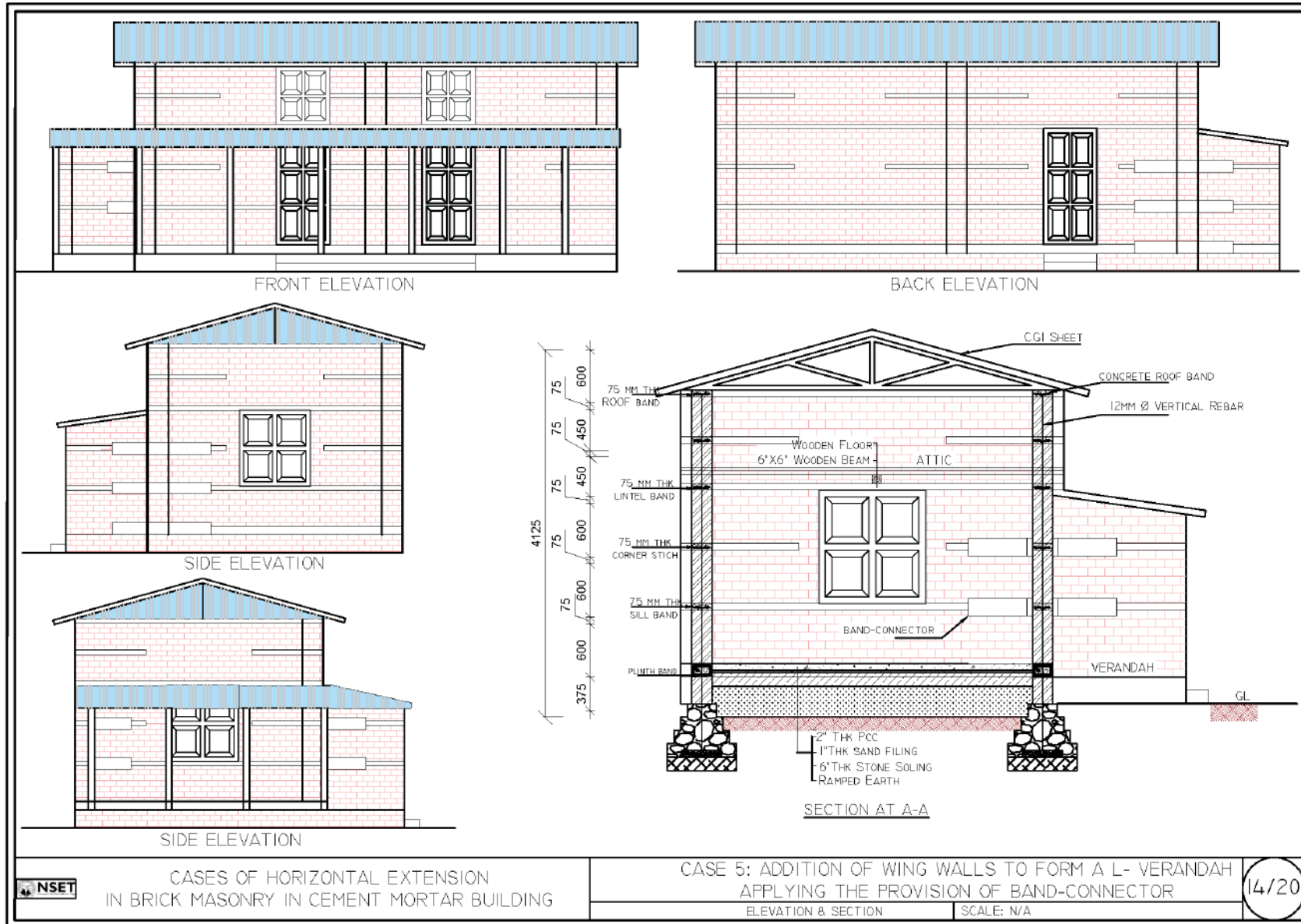

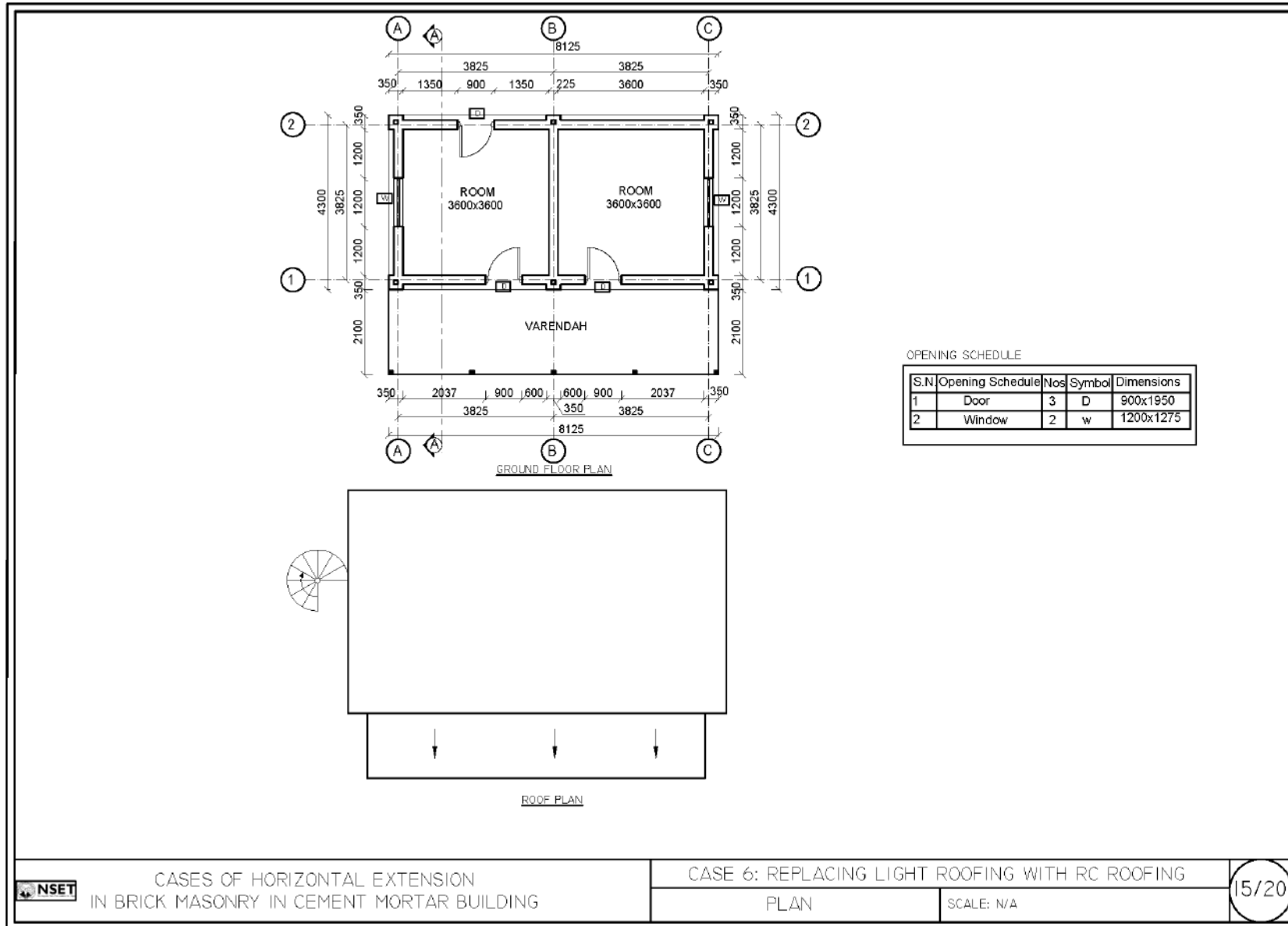

CASES OF HORIZONTAL EXTENSION  
IN BRICK MASONRY IN CEMENT MORTAR BUILDING

CASE 6: REPLACING LIGHT ROOFING WITH RC ROOFING

PLAN

SCALE: N/A

5/20

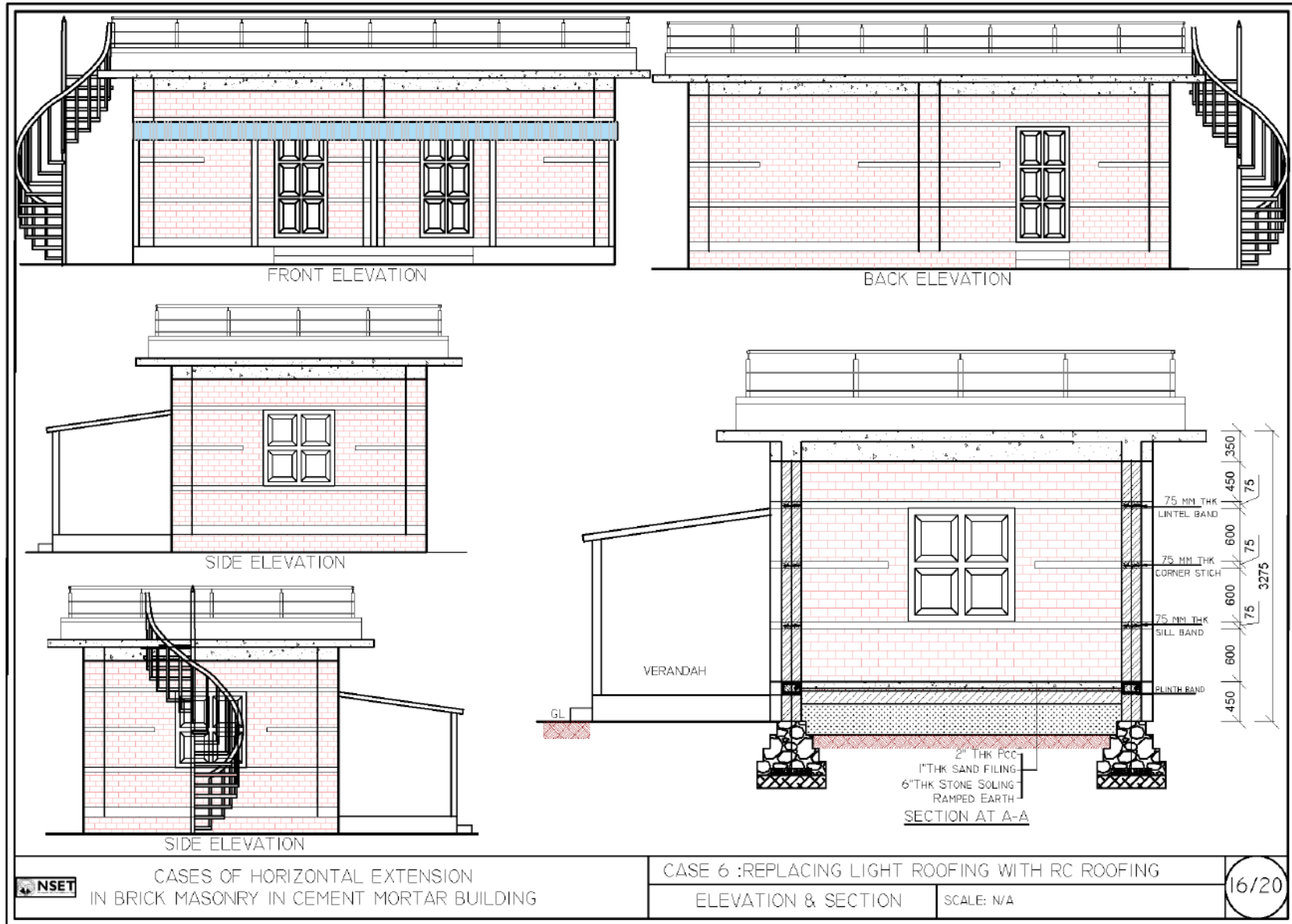

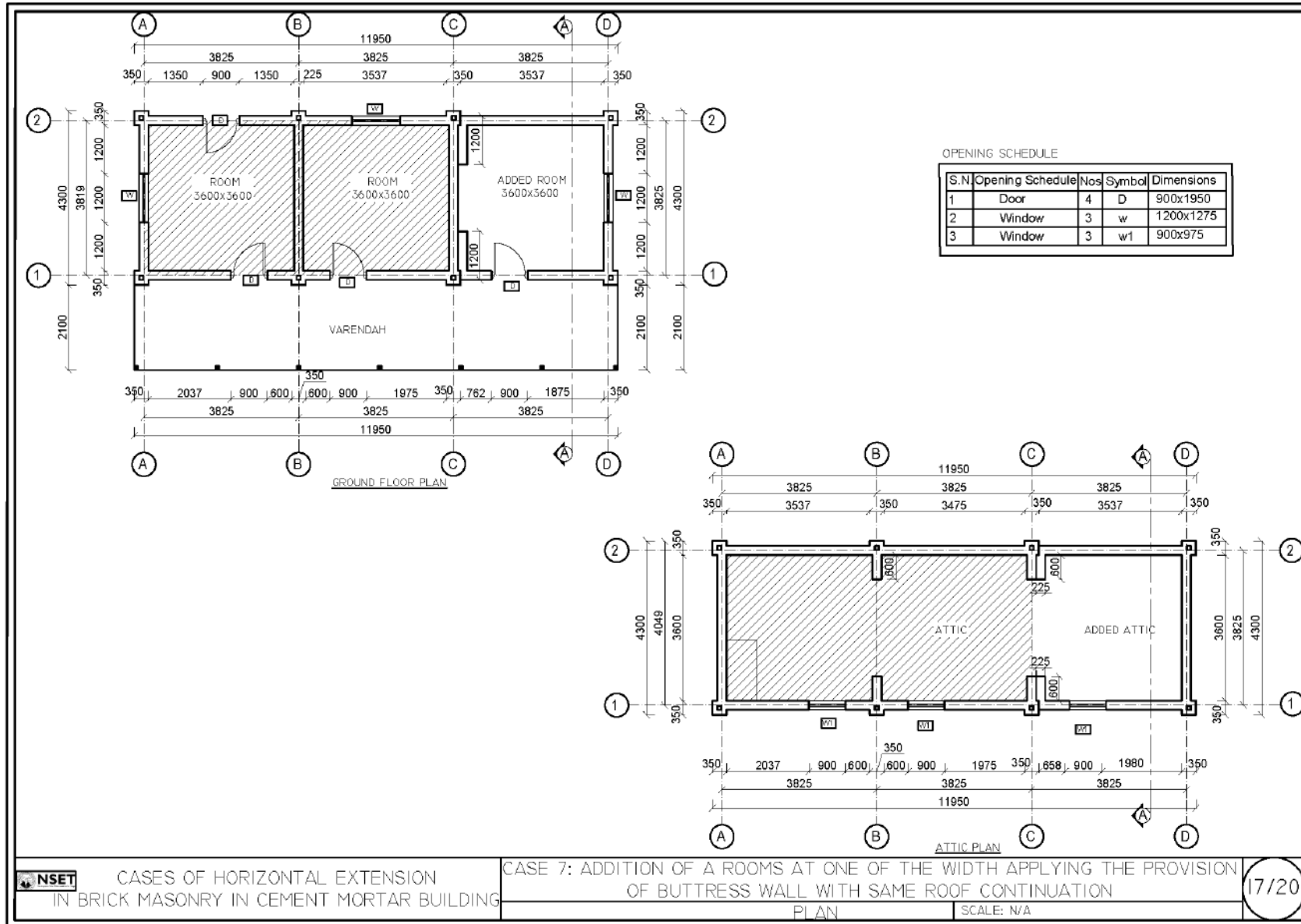

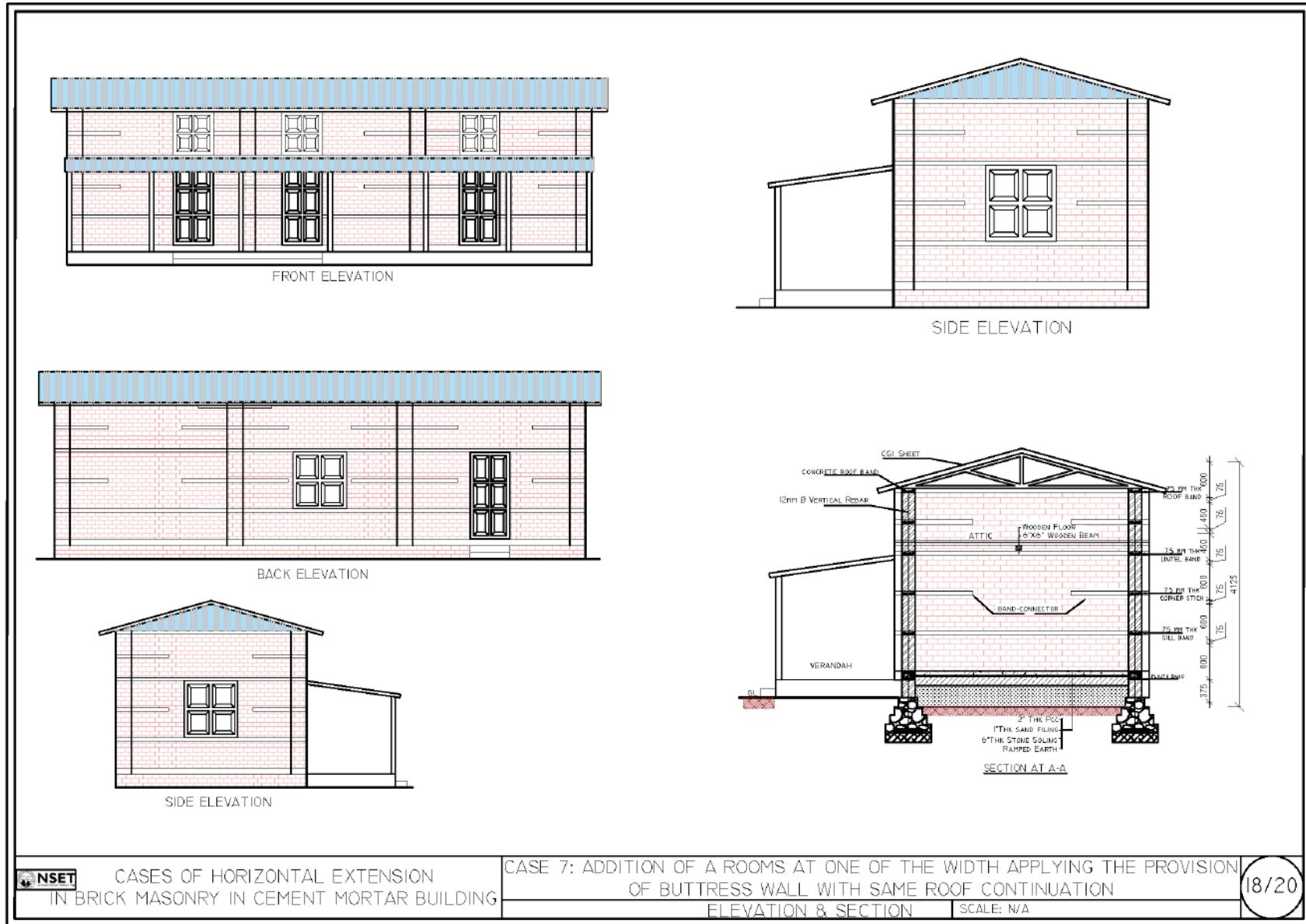

**NSET** CASES OF HORIZONTAL EXTENSION  
IN BRICK MASONRY IN CEMENT MORTAR BUILDING

CASE 7: ADDITION OF A ROOMS AT ONE OF THE WIDTH APPLYING THE PROVISION  
OF BUTTRESS WALL WITH SAME ROOF CONTINUATION  
ELEVATION & SECTION SCALE: N/A

18/20

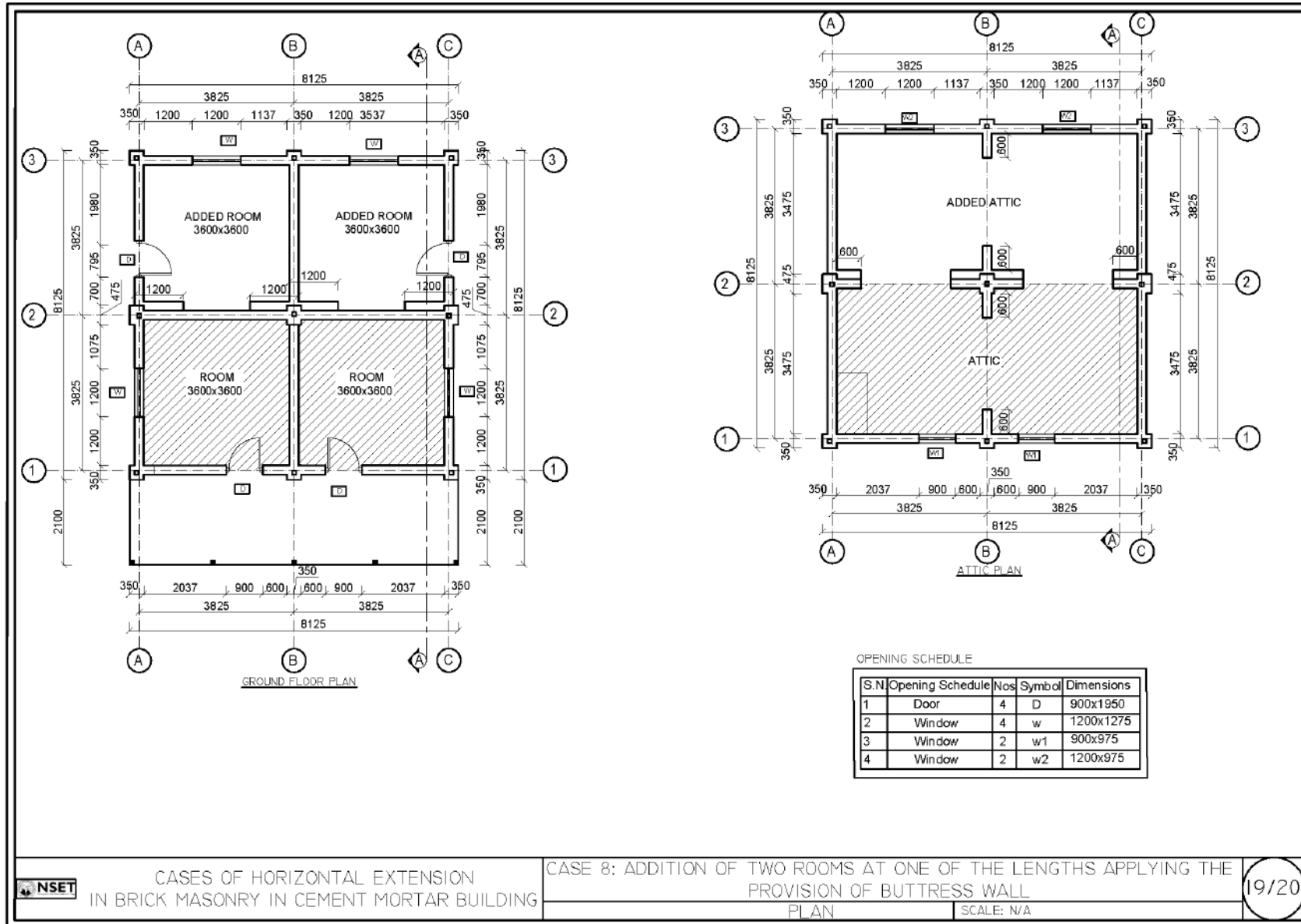



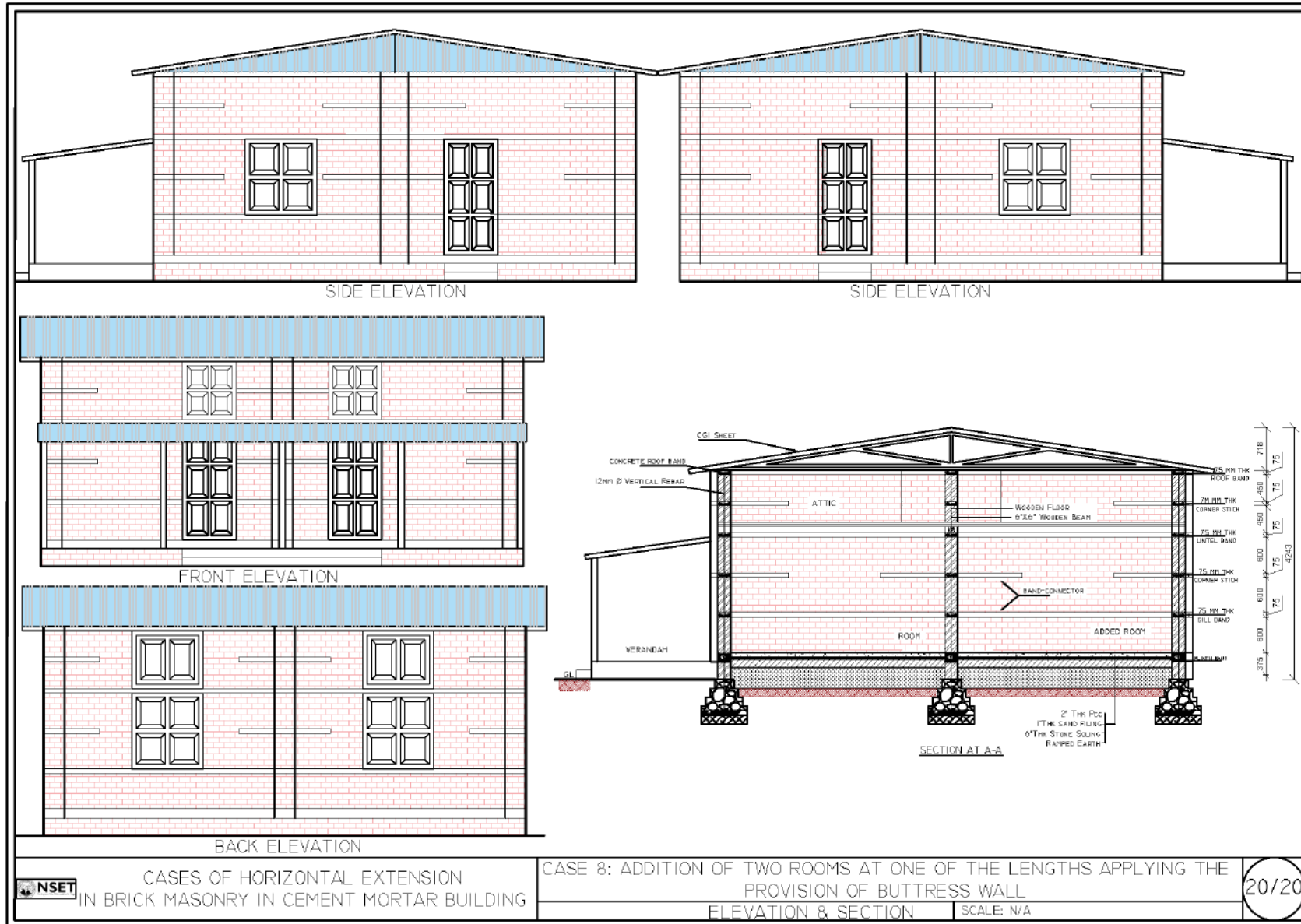

CASES OF HORIZONTAL EXTENSION  
IN BRICK MASONRY IN CEMENT MORTAR BUILDING

CASE 8: ADDITION OF TWO ROOMS AT ONE OF THE LENGTHS APPLYING THE  
PROVISION OF BUTTRESS WALL  
ELEVATION & SECTION SCALE: N/A

20/20

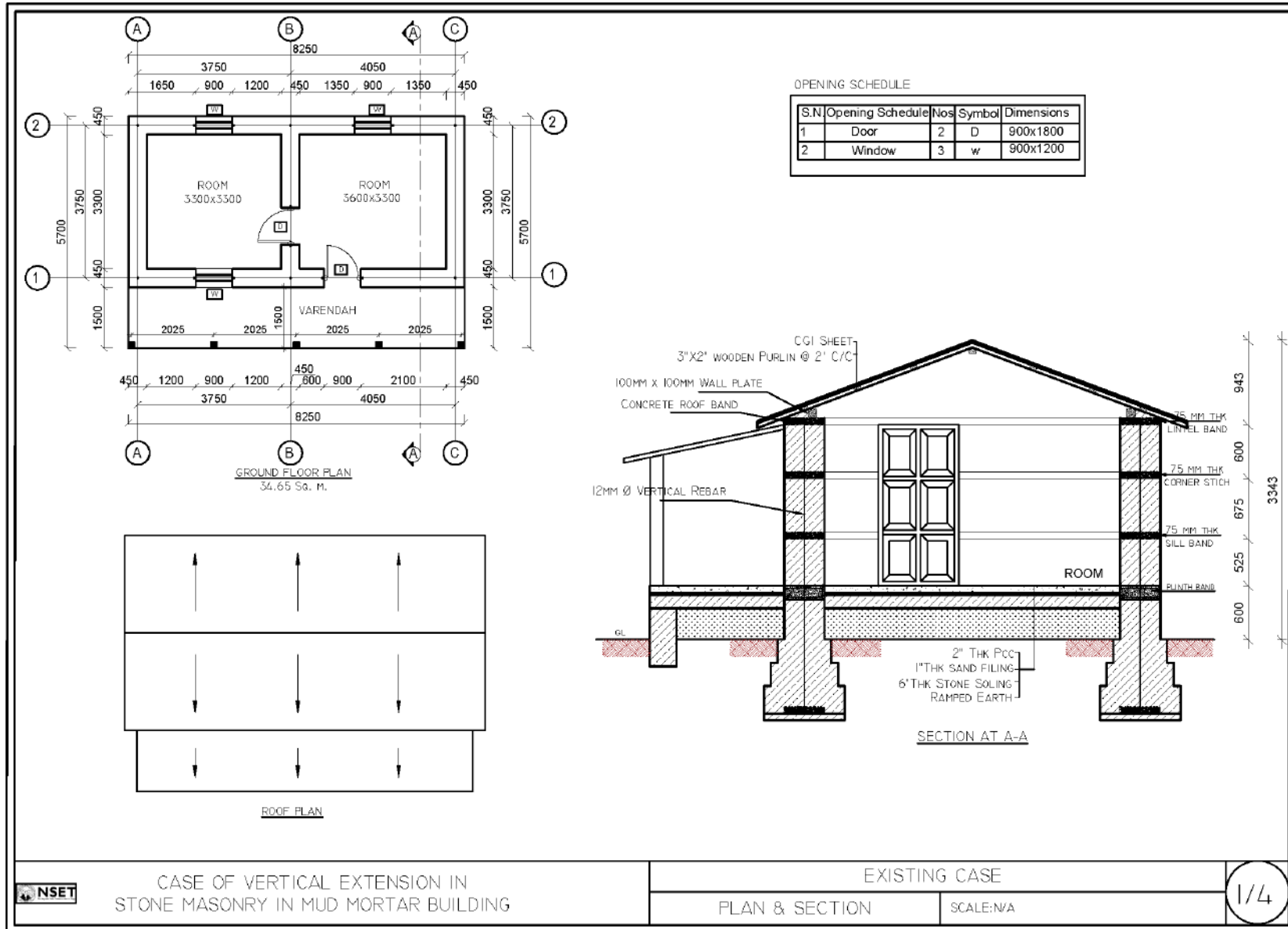

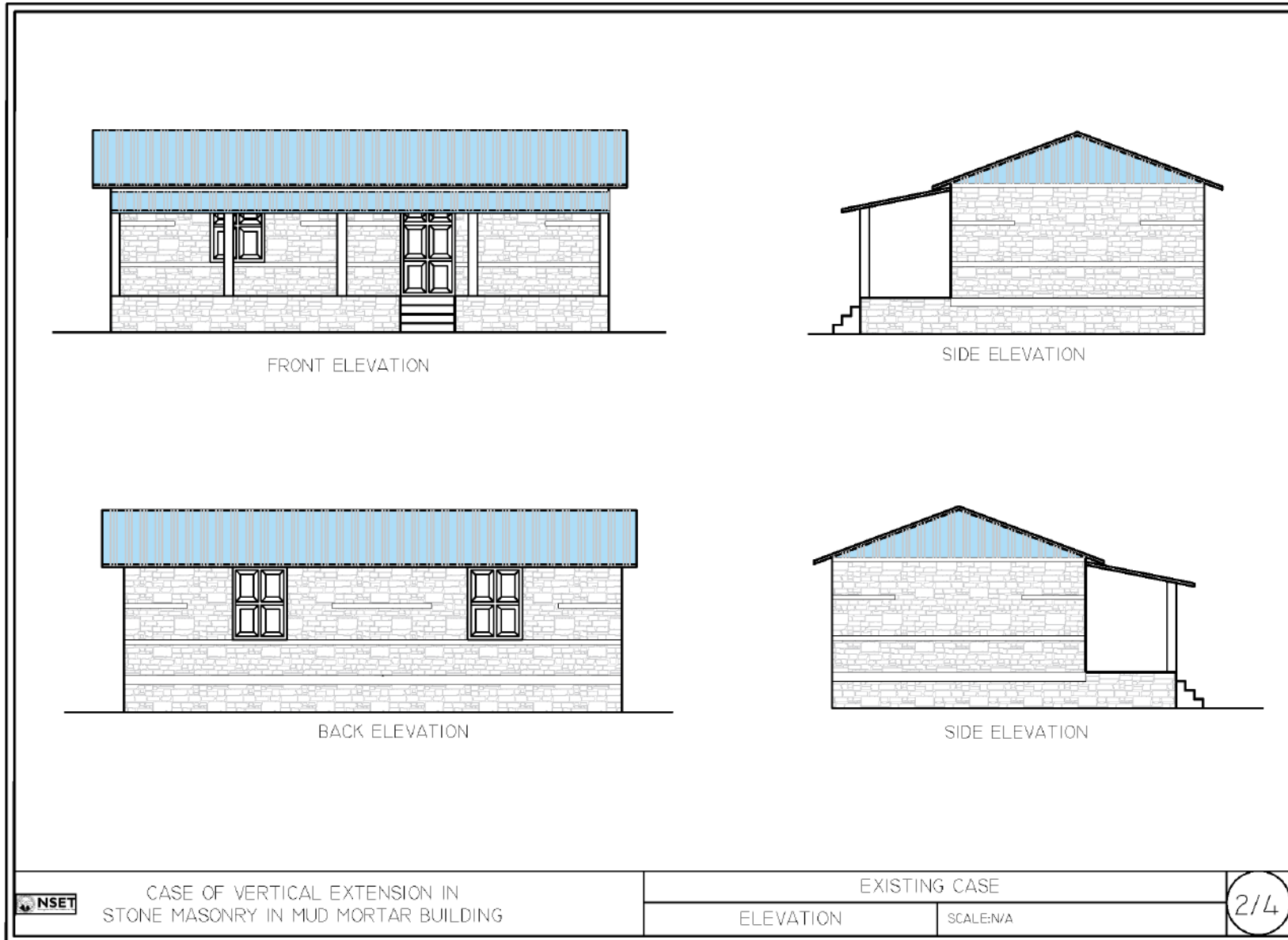

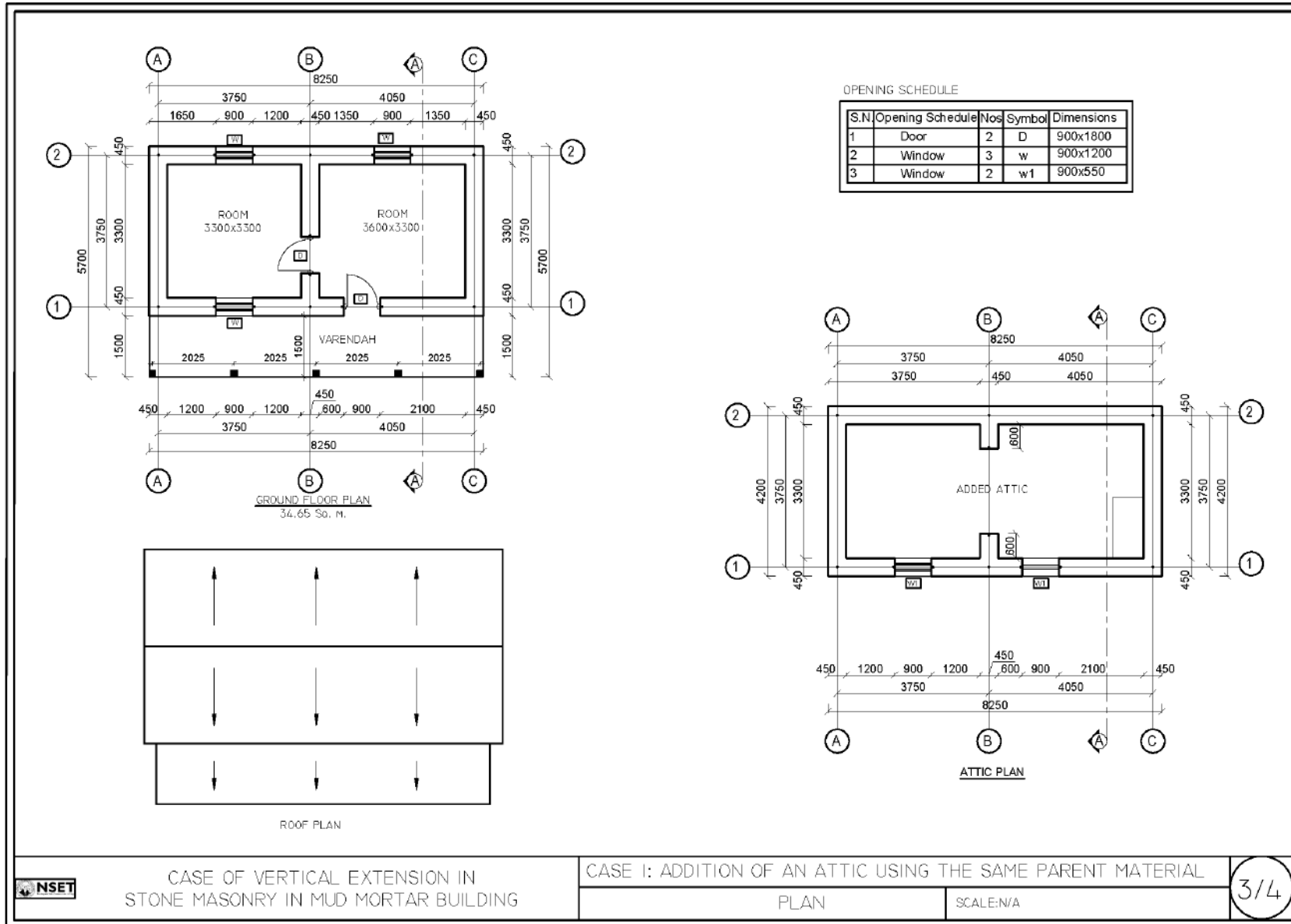

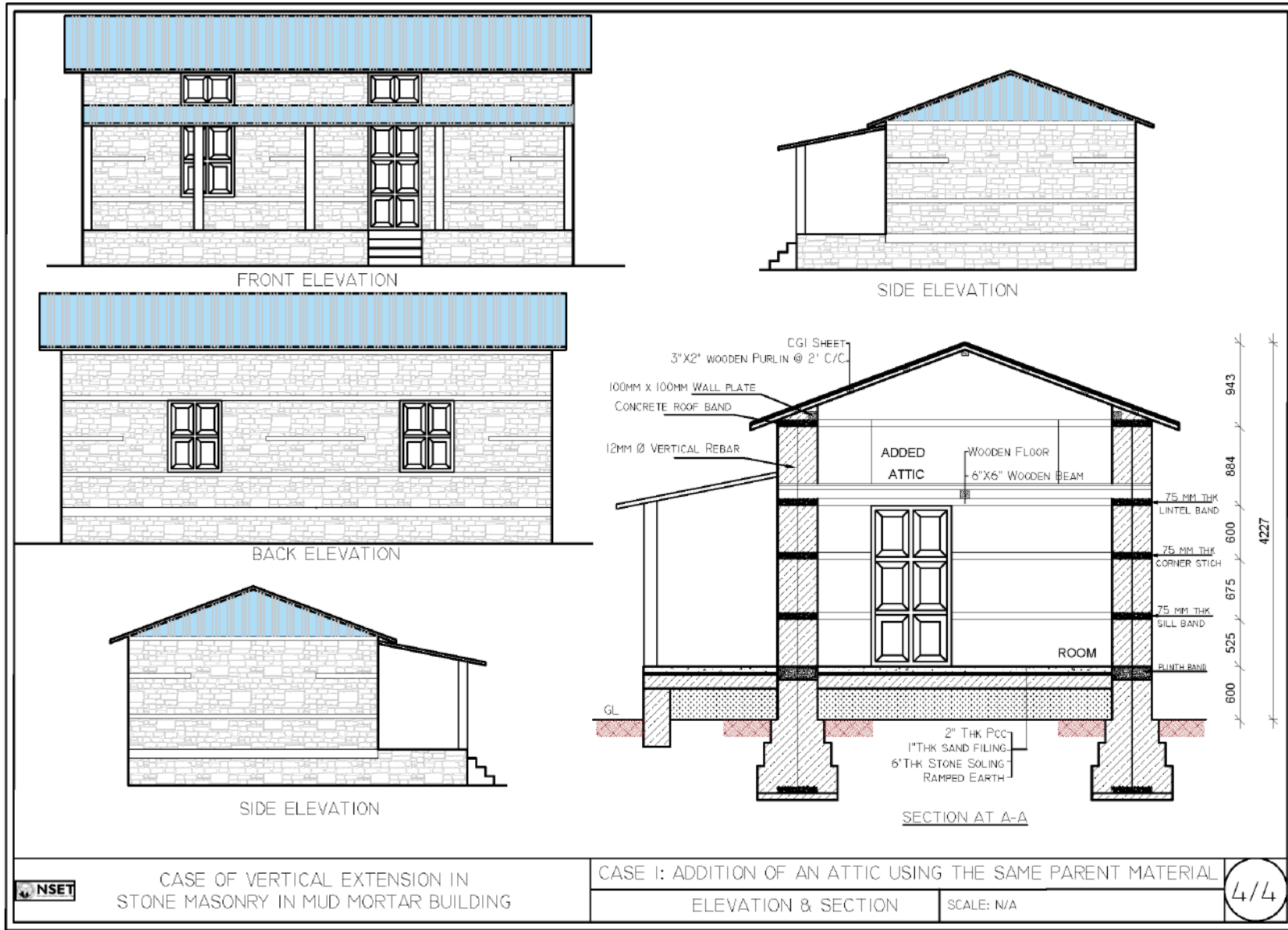

NSET CASE OF VERTICAL EXTENSION IN STONE MASONRY IN MUD MORTAR BUILDING

CASE I: ADDITION OF AN ATTIC USING THE SAME PARENT MATERIAL  
ELEVATION & SECTION SCALE: N/A

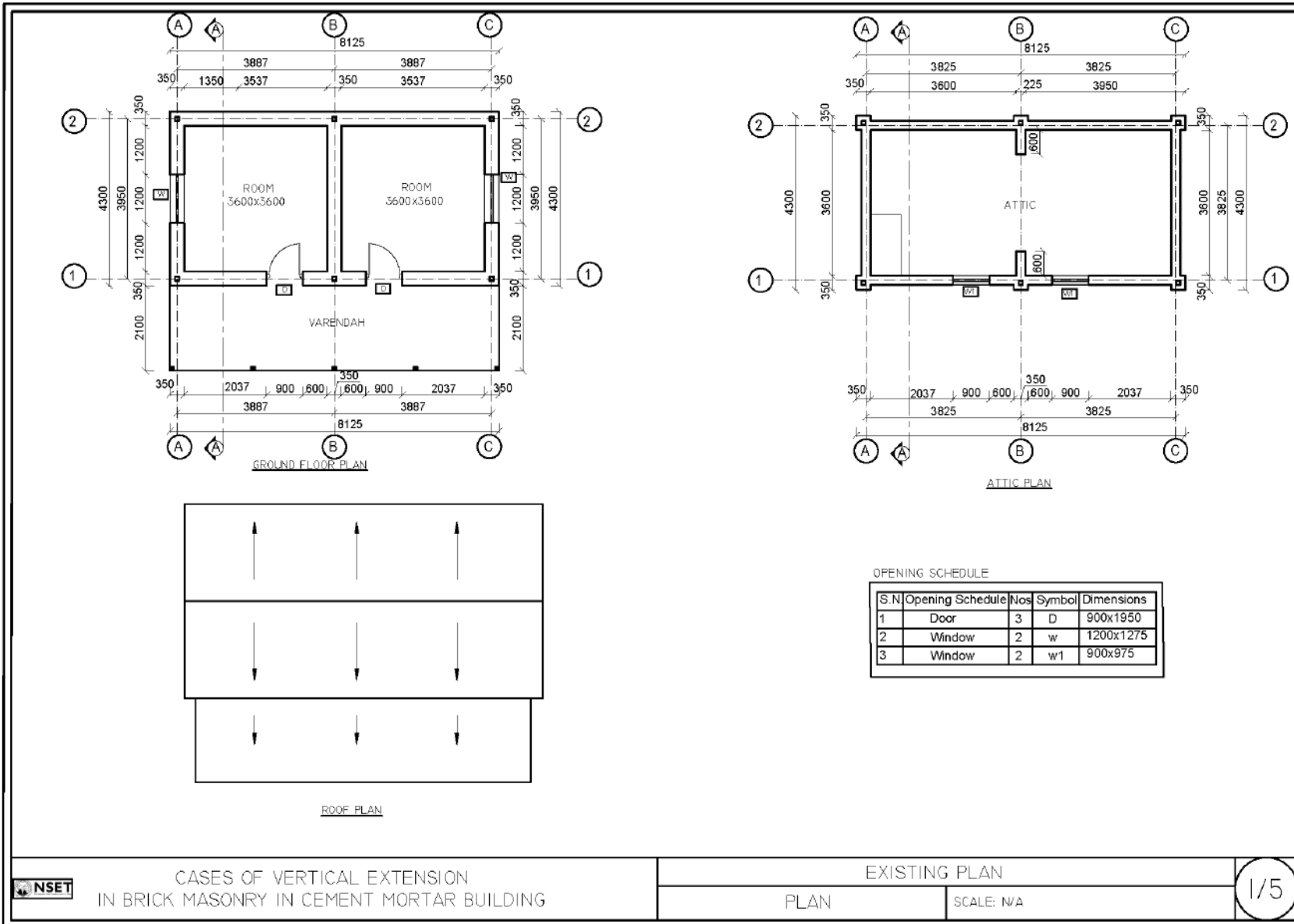

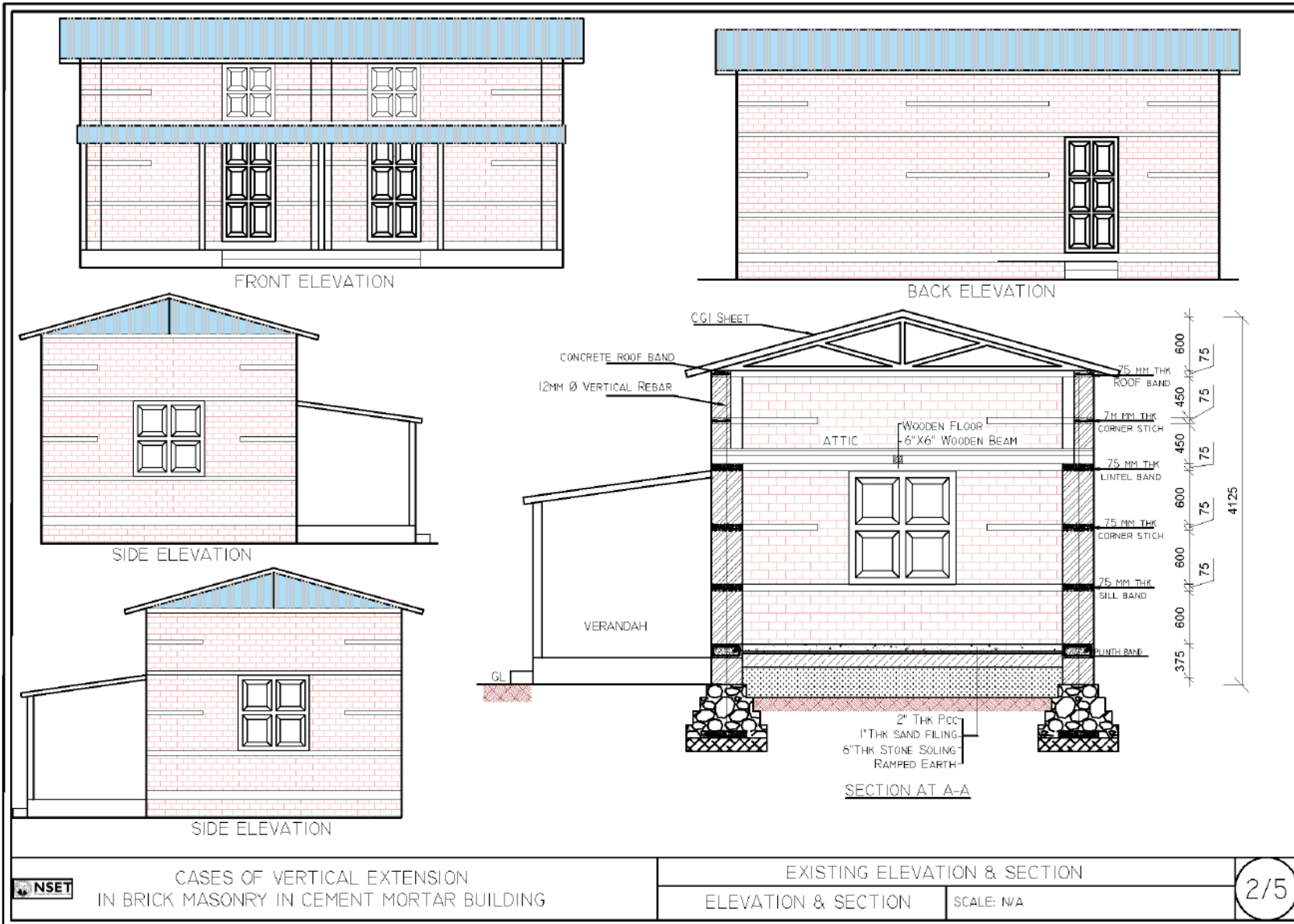

	CASES OF VERTICAL EXTENSION IN BRICK MASONRY IN CEMENT MORTAR BUILDING		EXISTING ELEVATION & SECTION ELEVATION & SECTION		SCALE: N/A	2/5

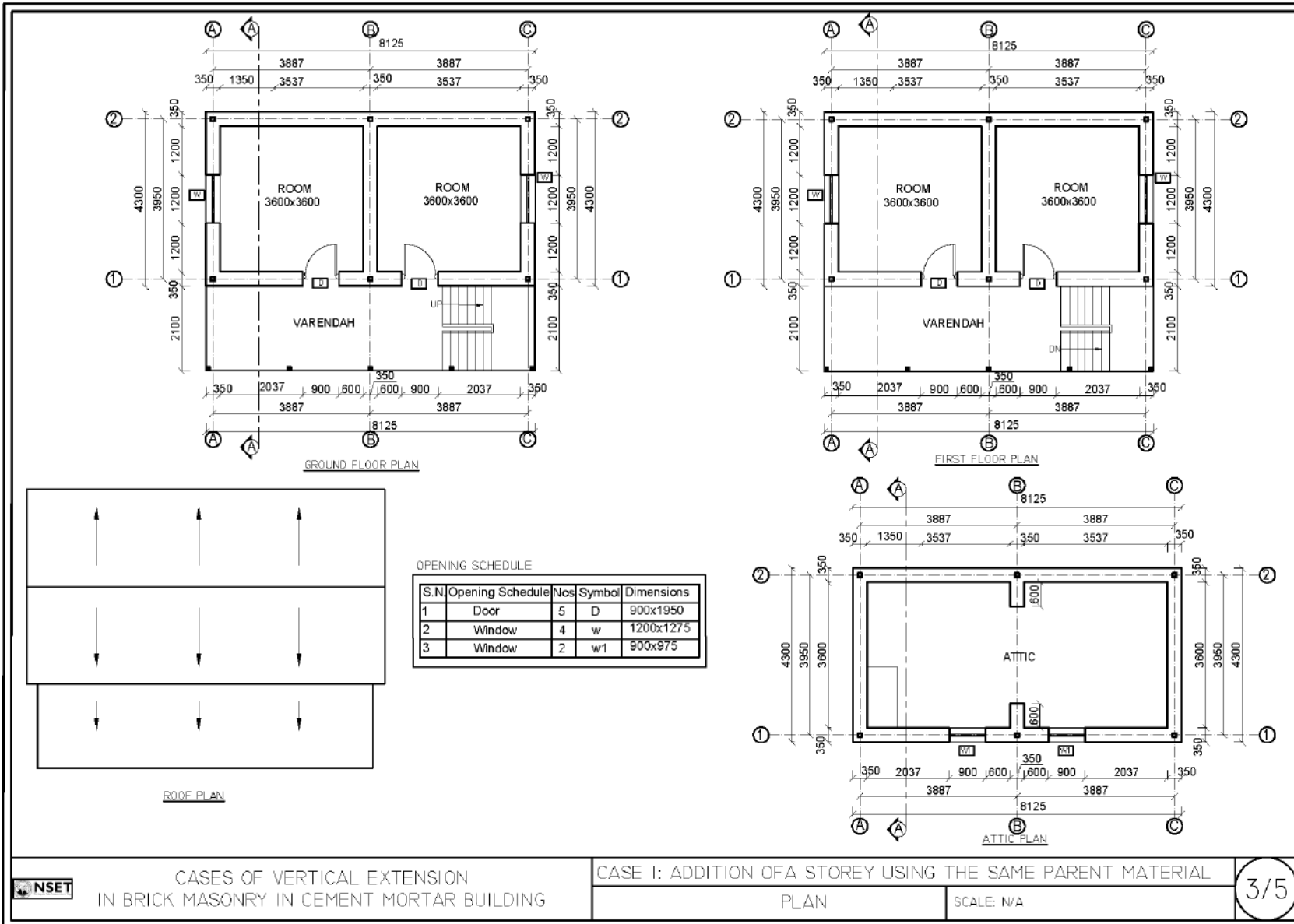





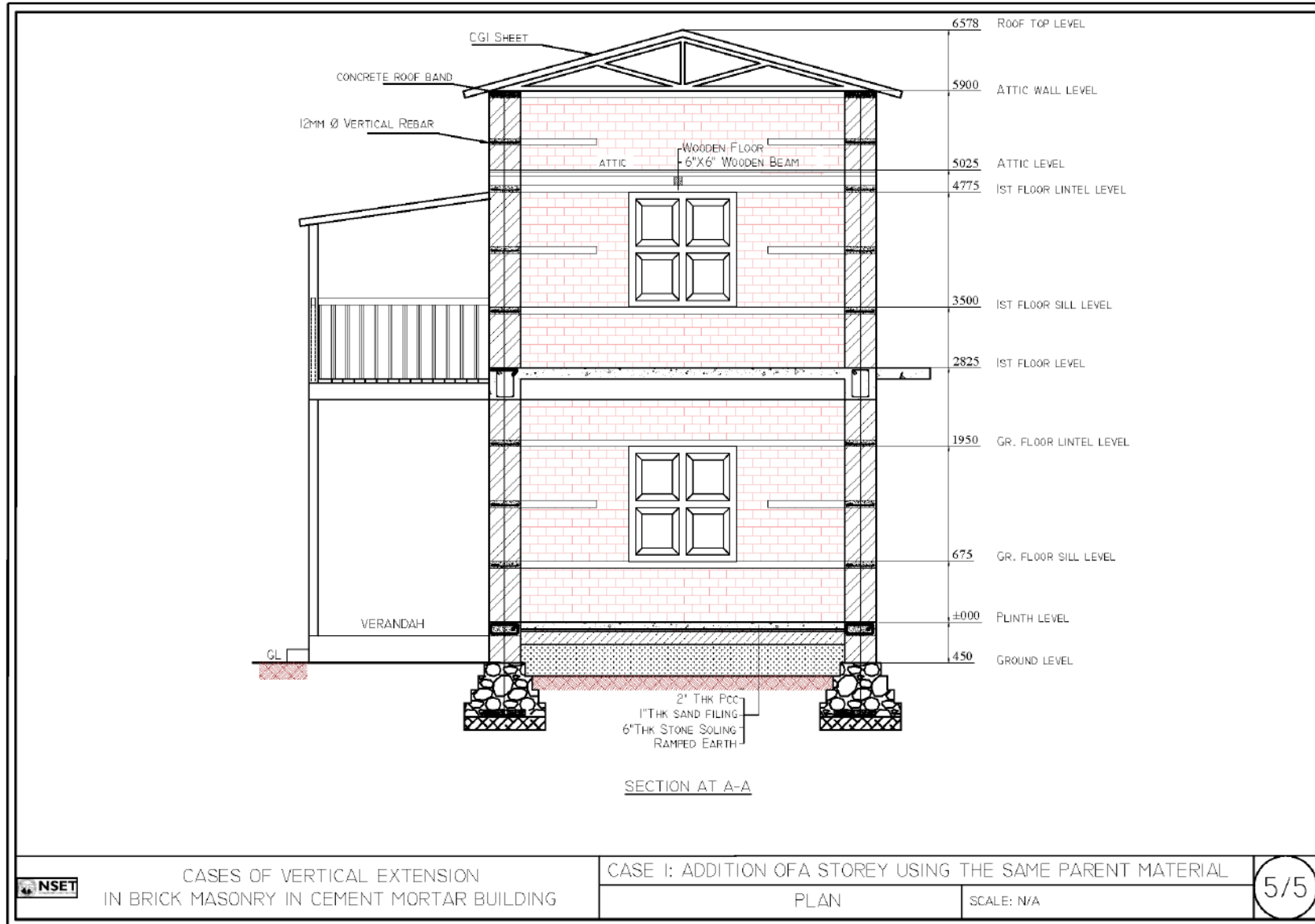

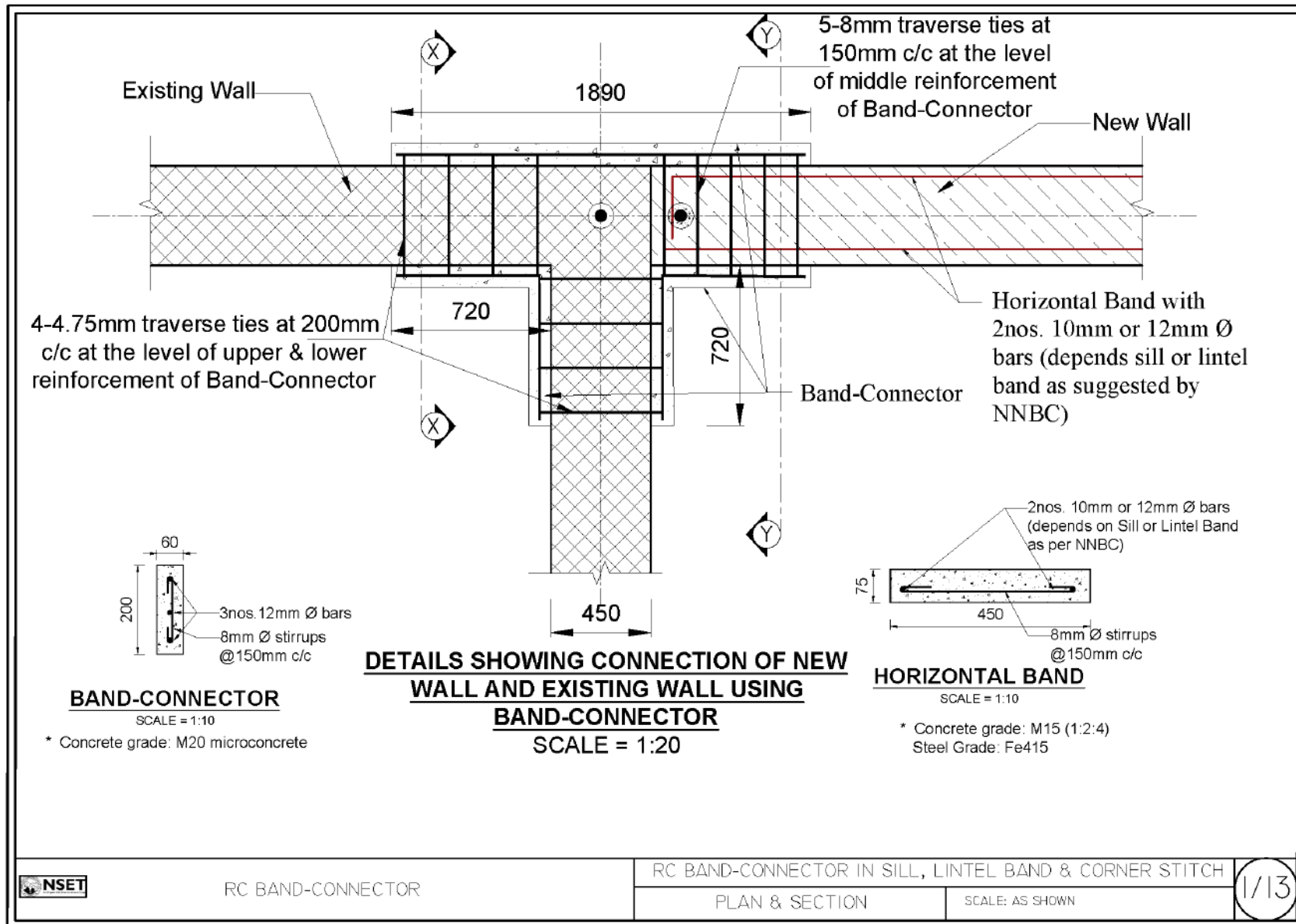

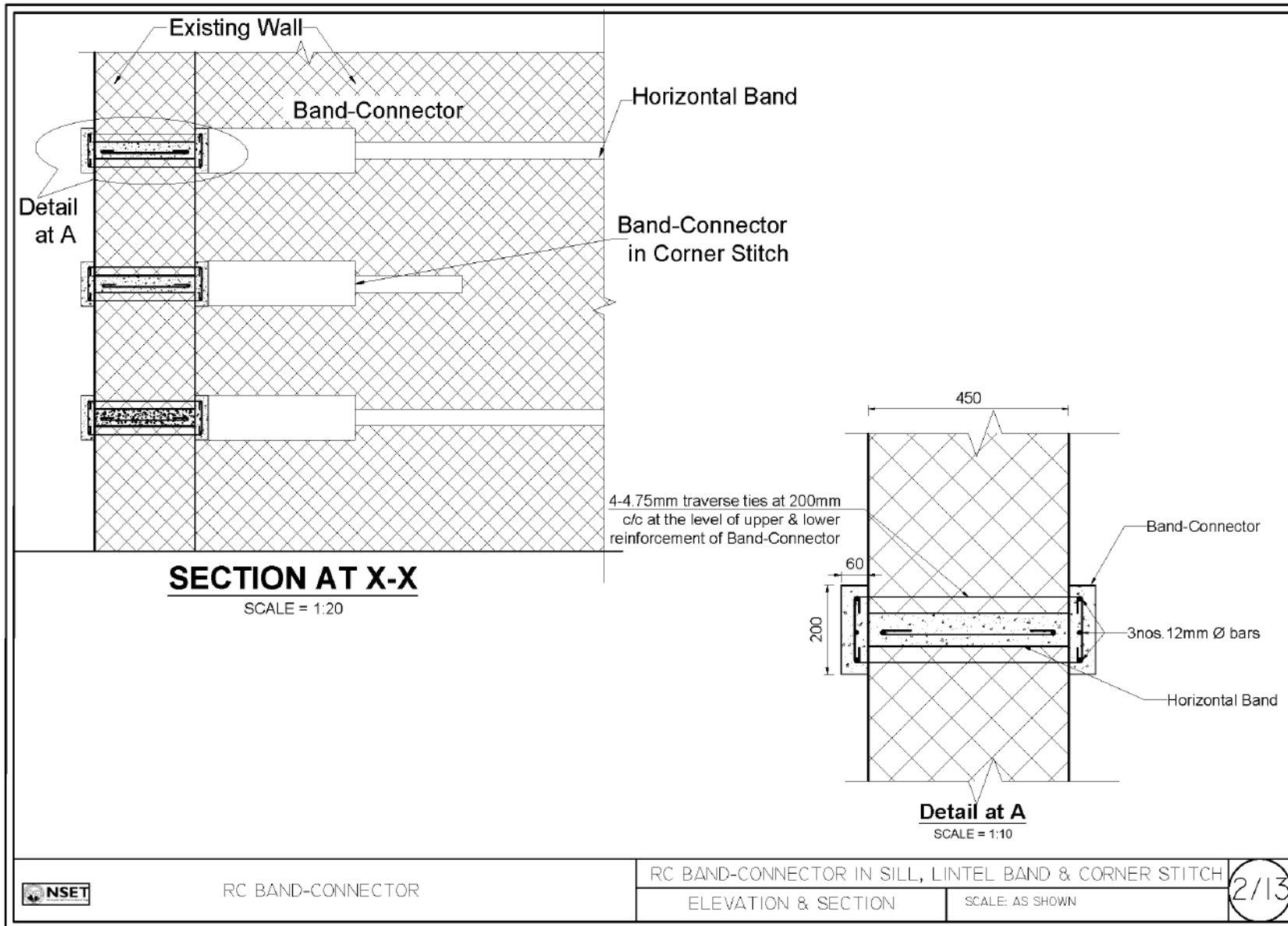

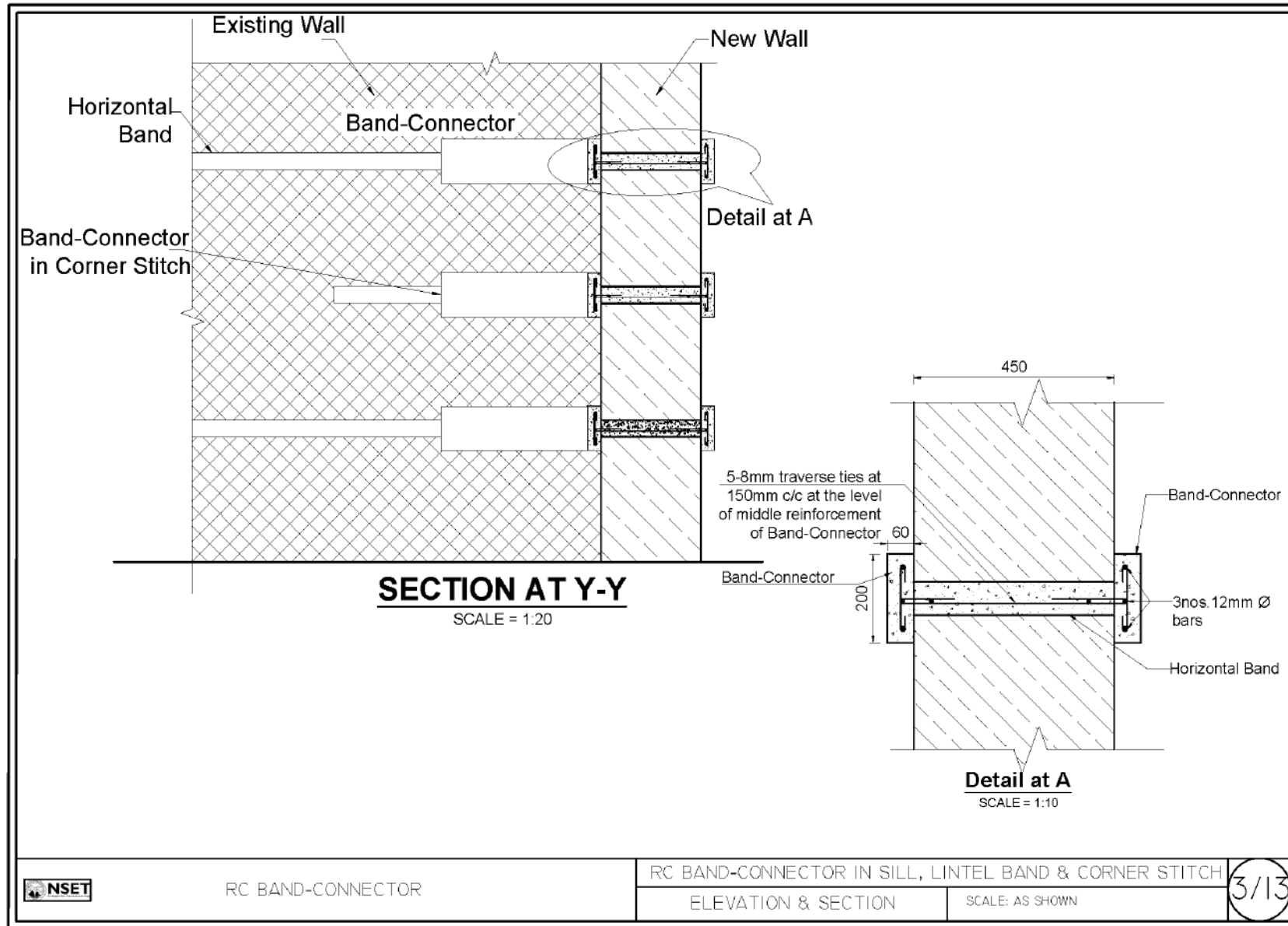

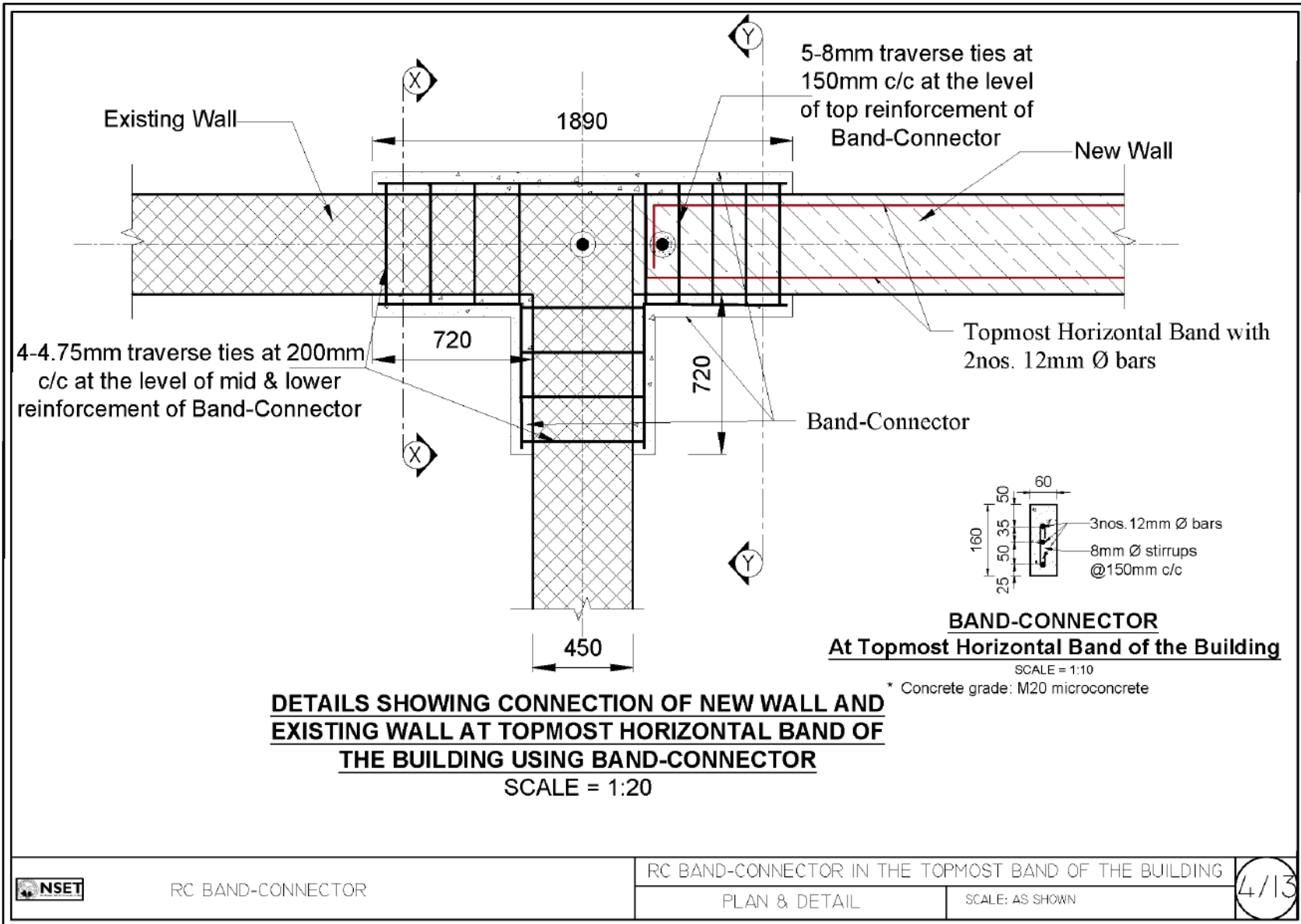

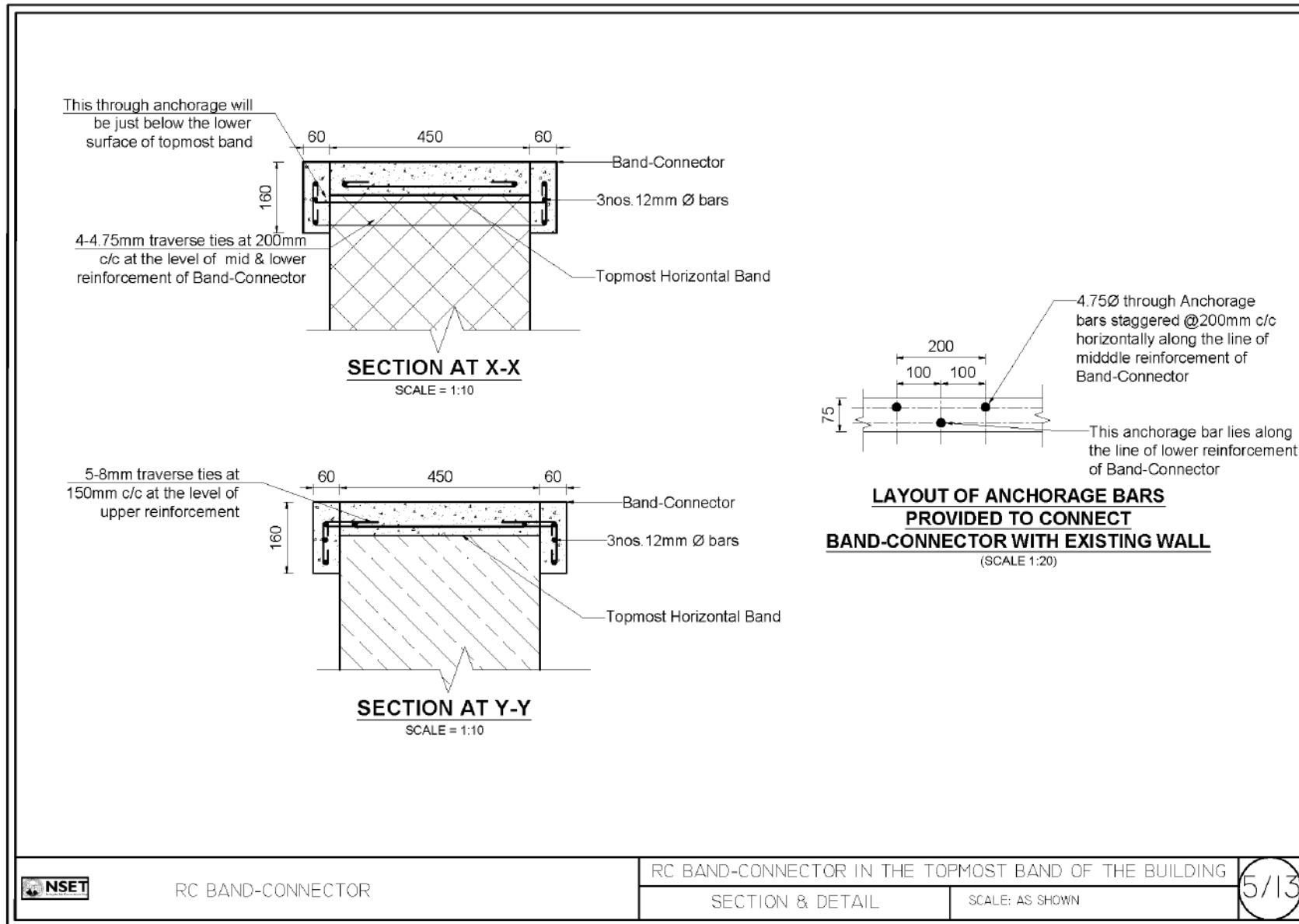

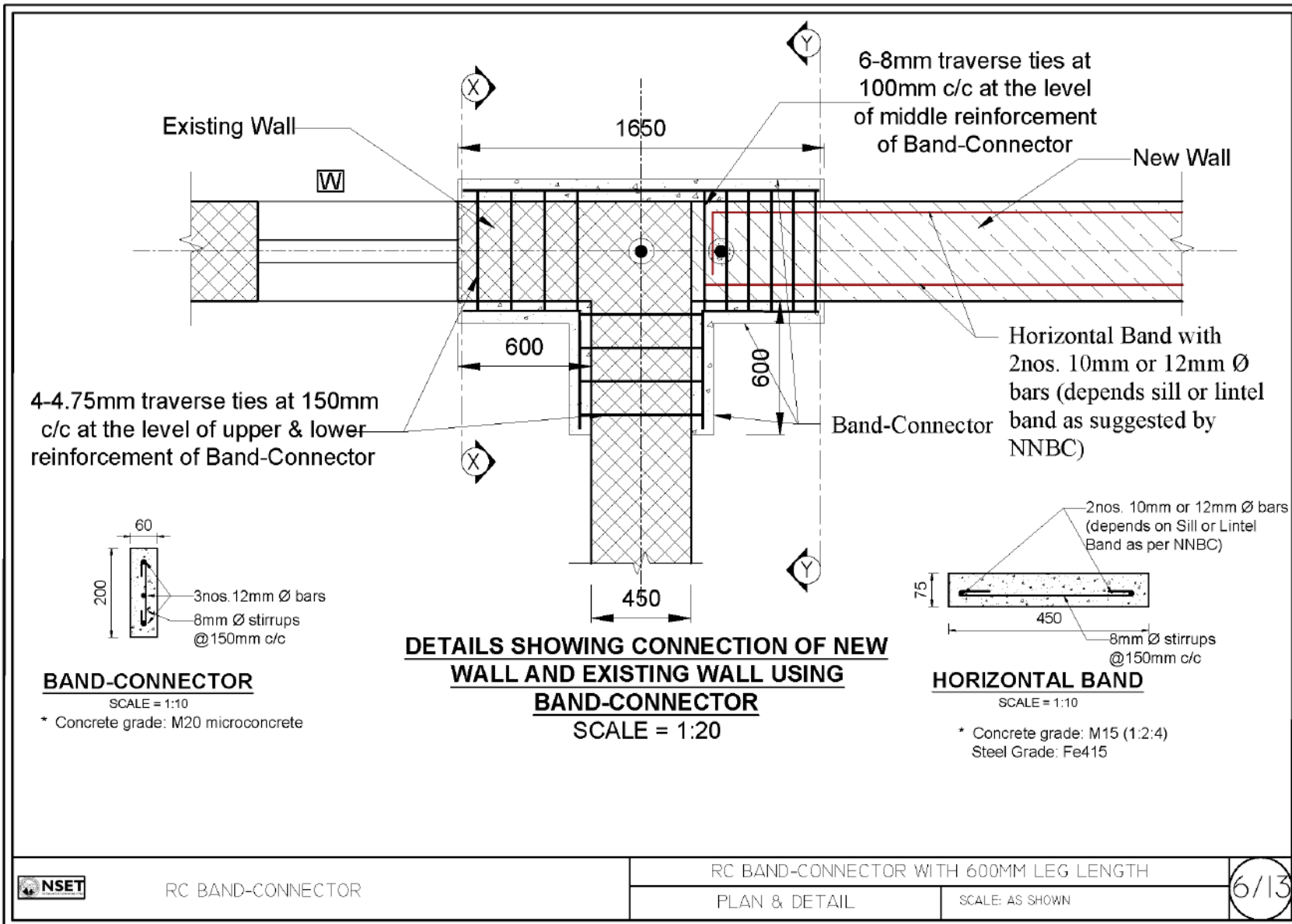



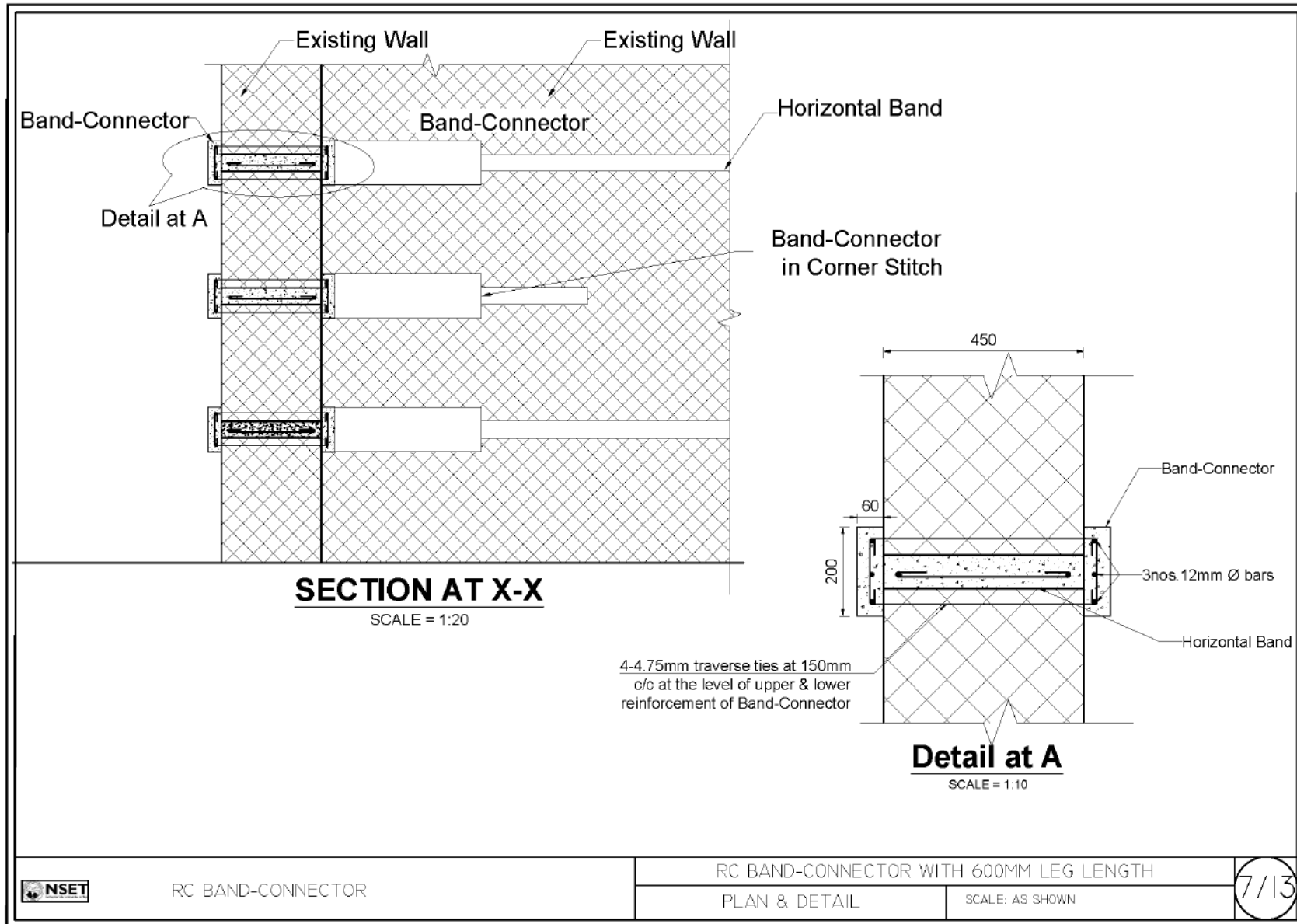

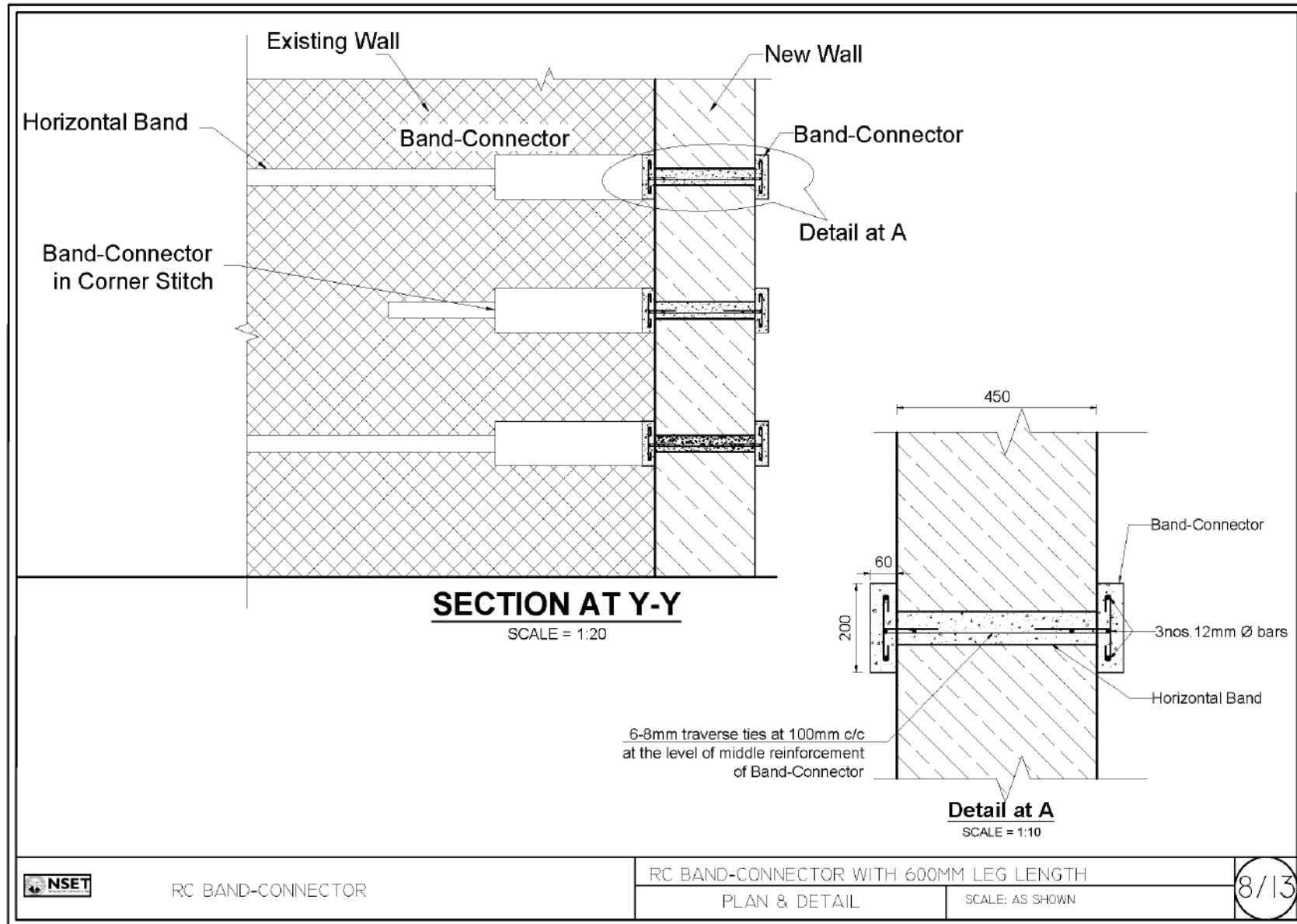

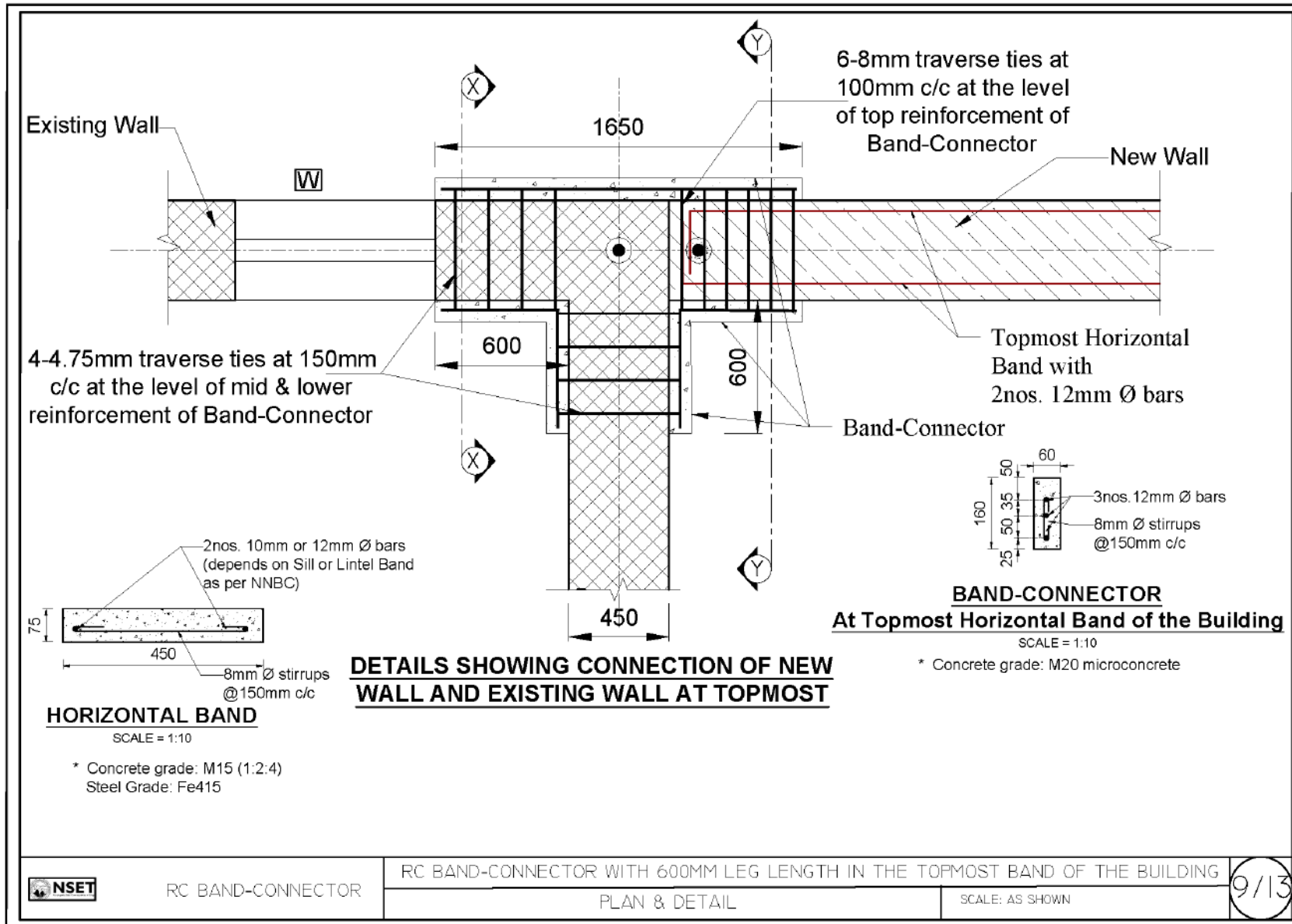

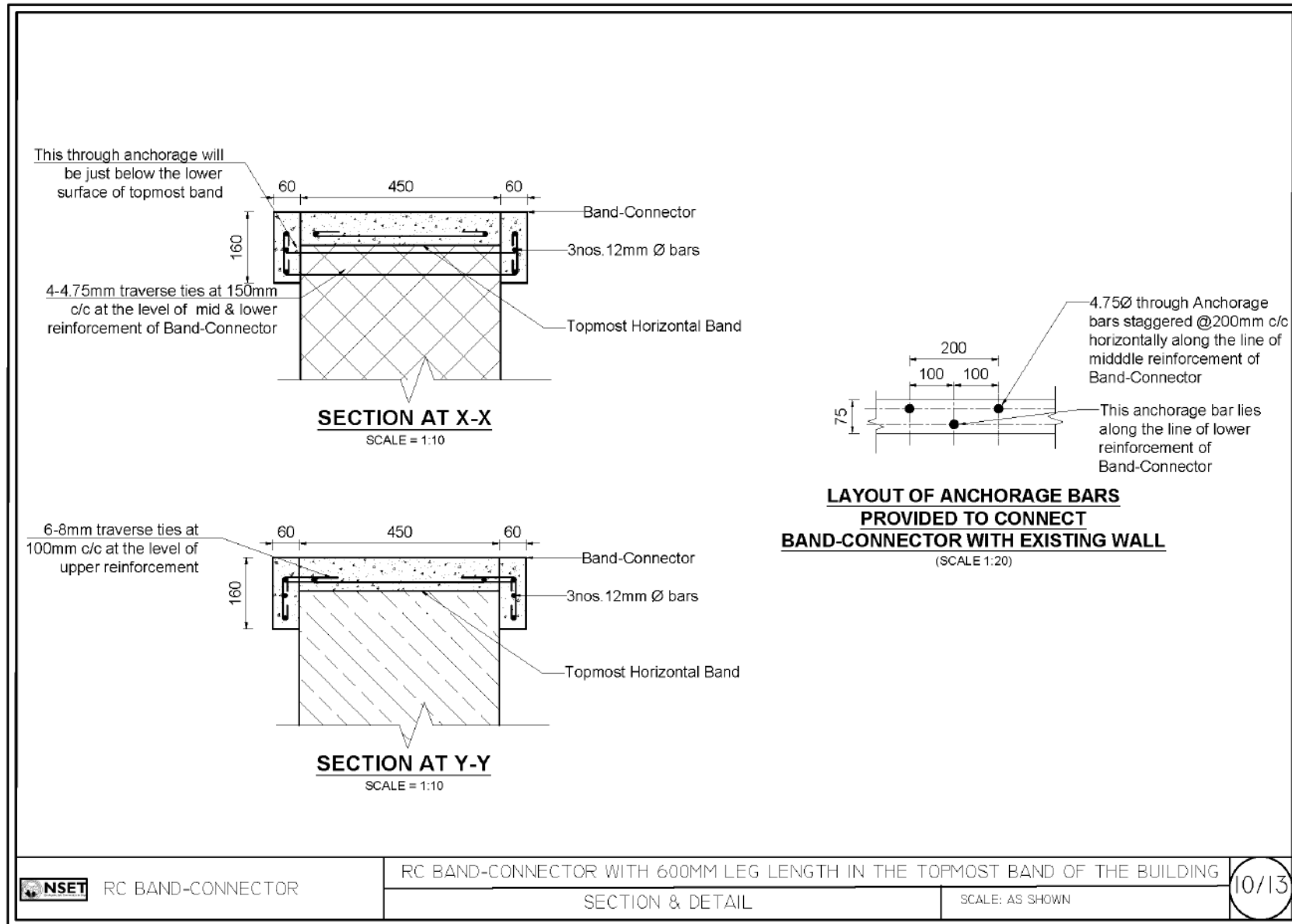

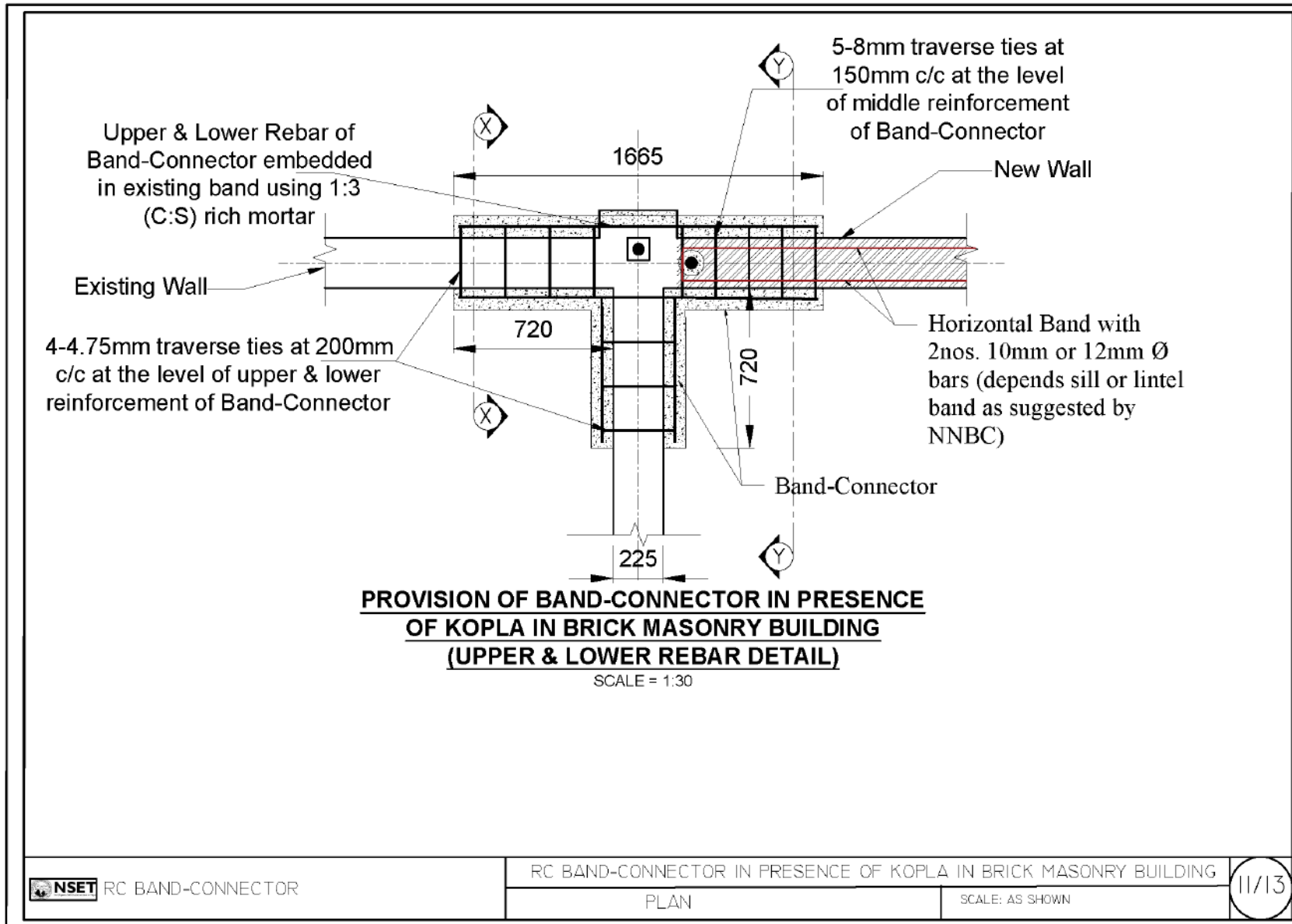

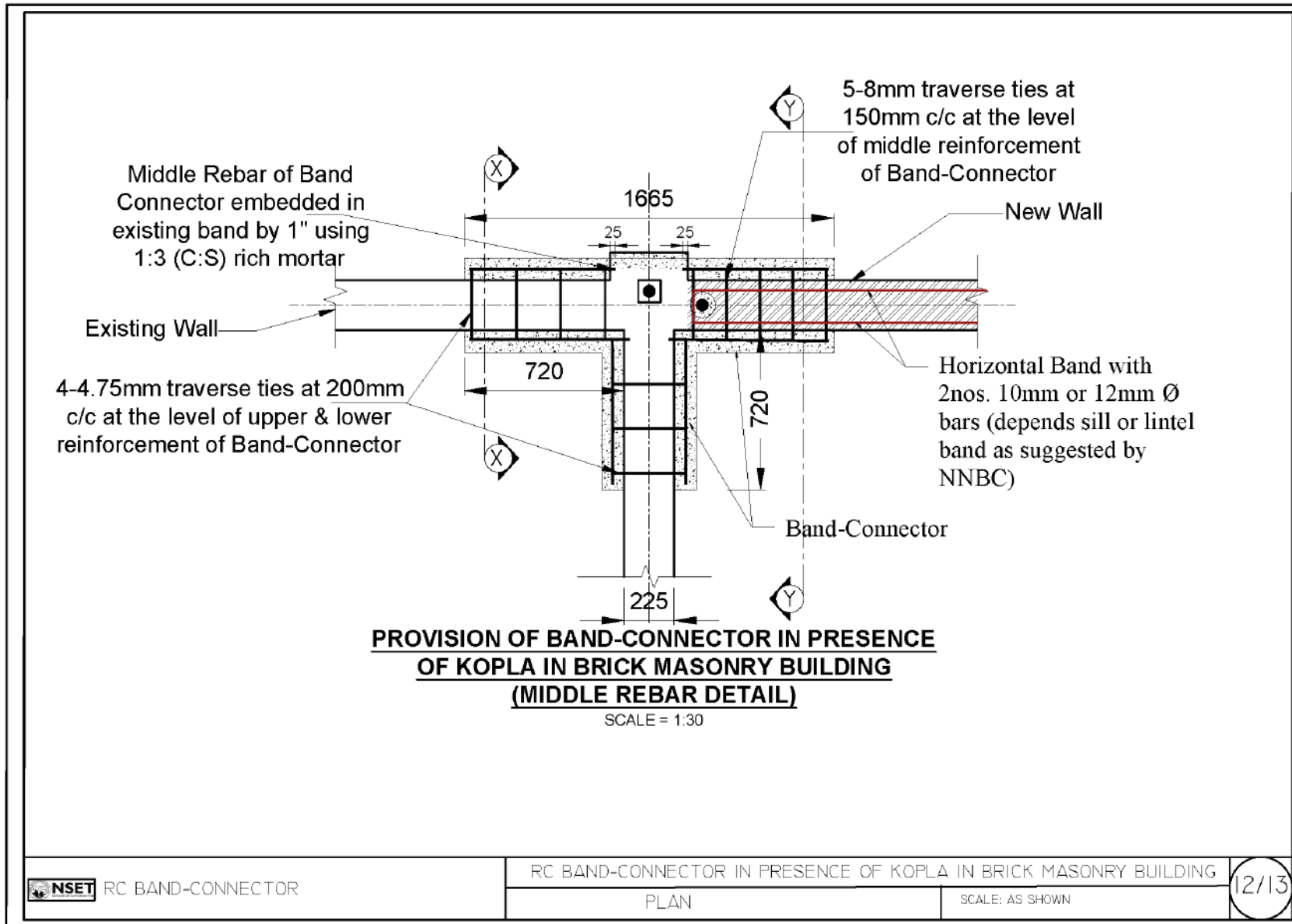

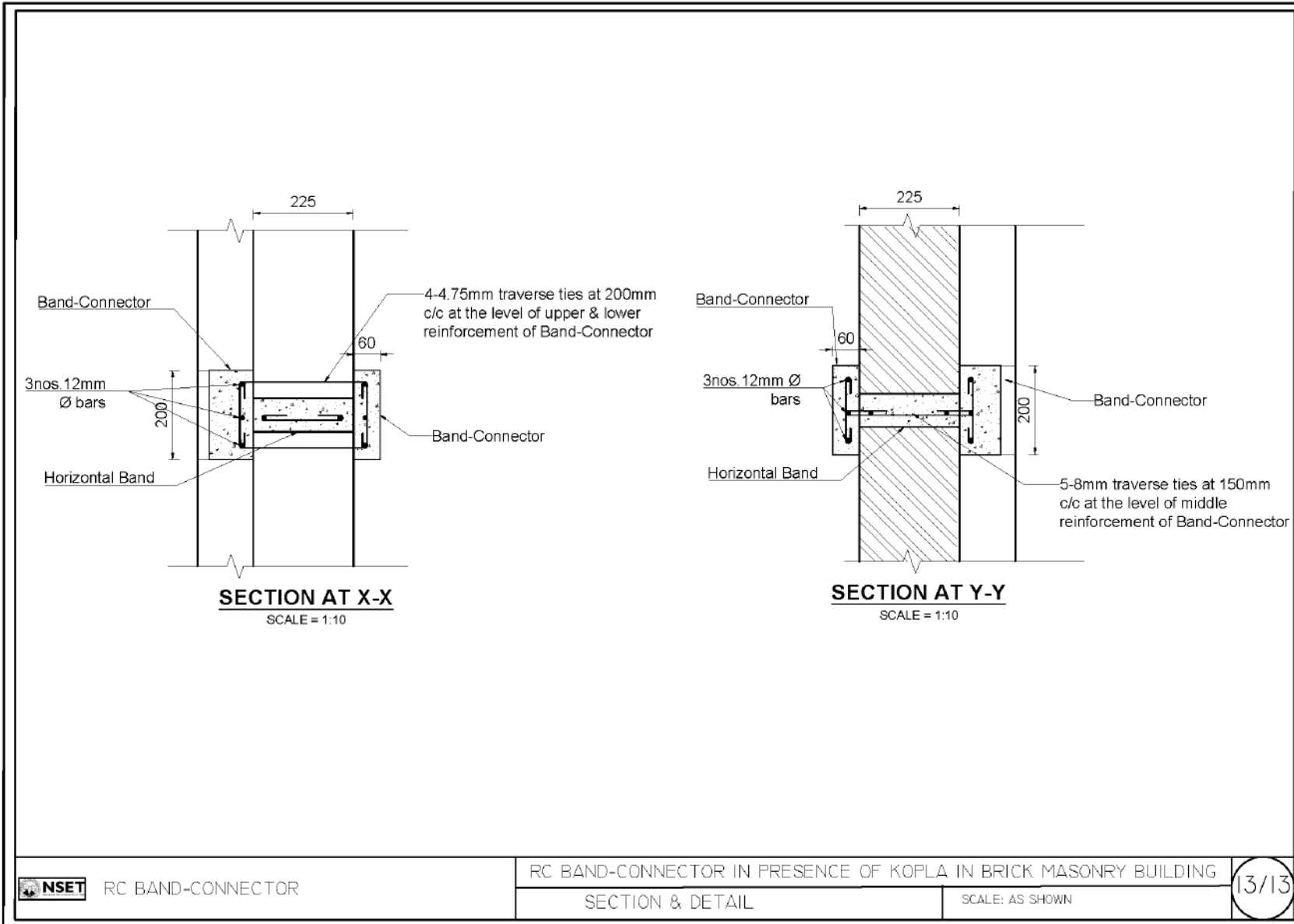

RC BAND-CONNECTOR

RC BAND-CONNECTOR IN PRESENCE OF KOPLA IN BRICK MASONRY BUILDING

SECTION & DETAIL

SCALE: AS SHOWN

13/13

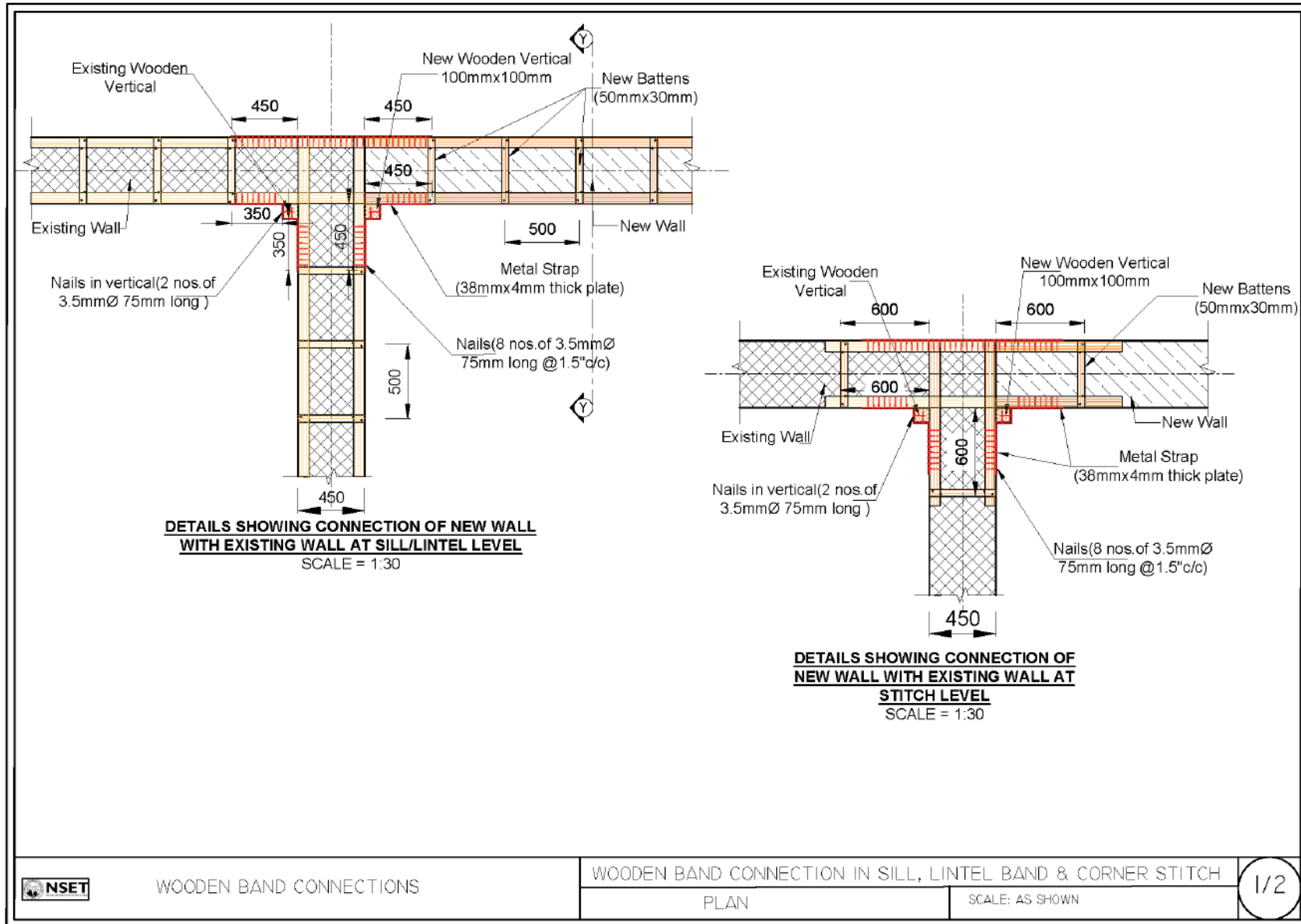



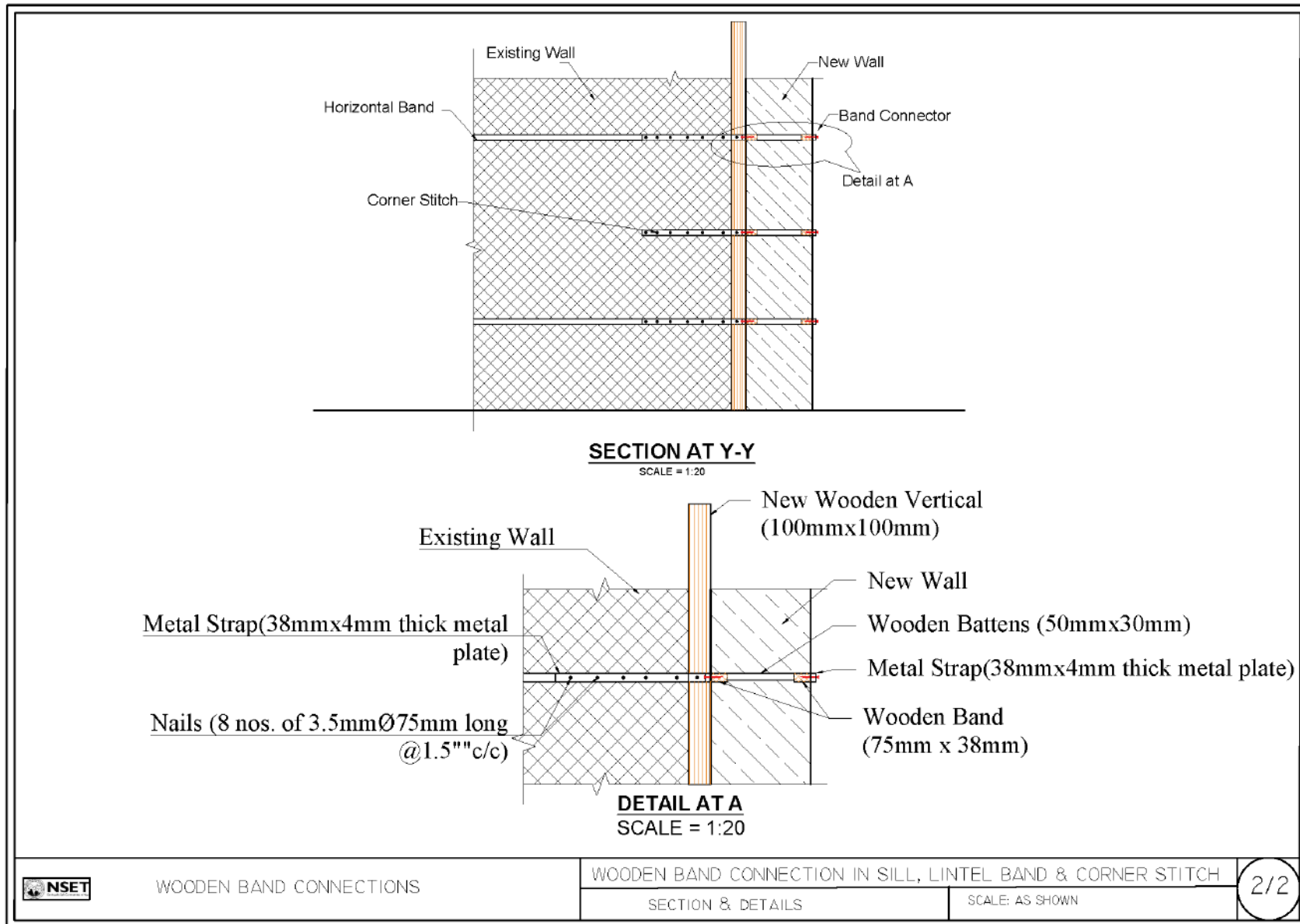

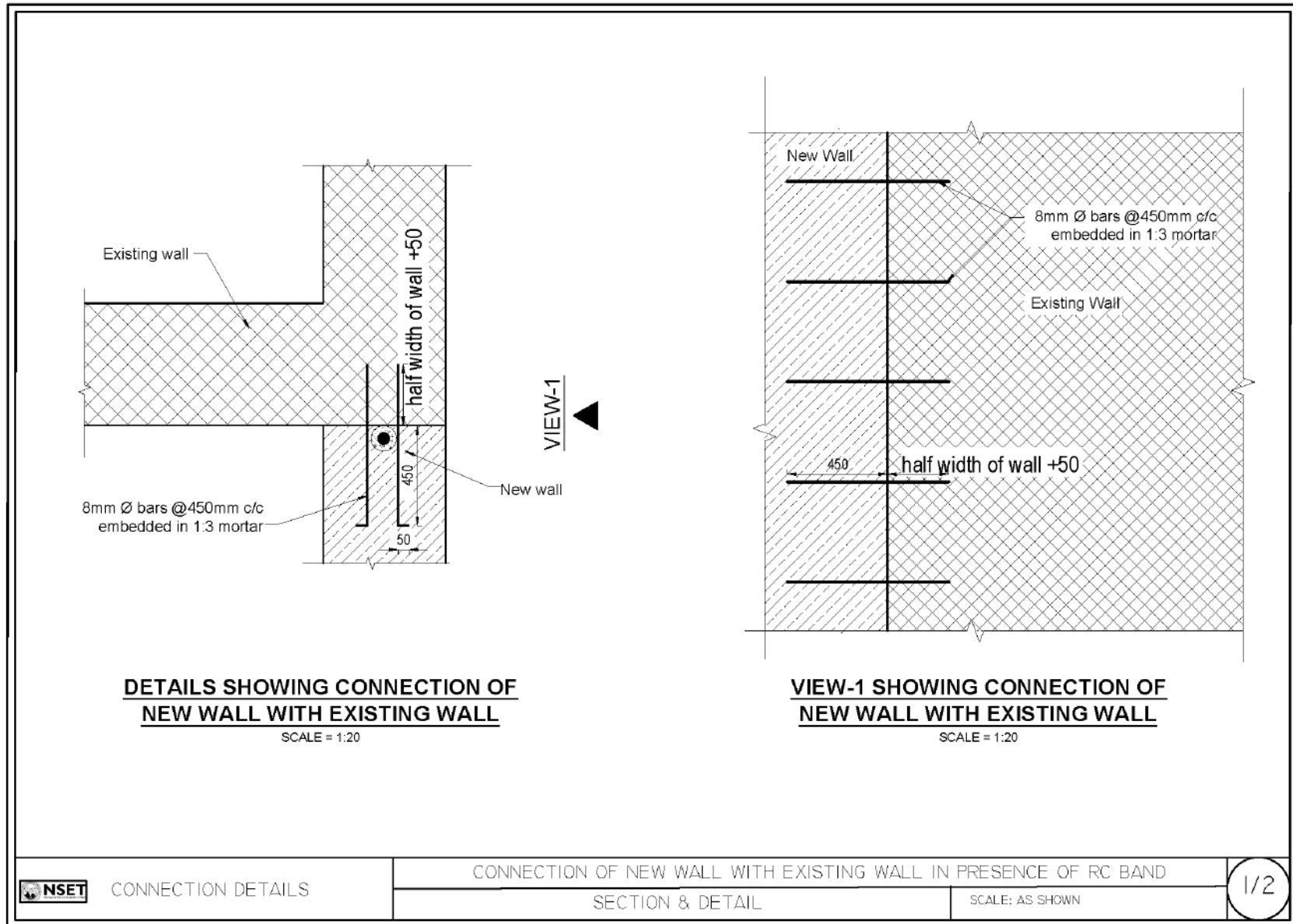

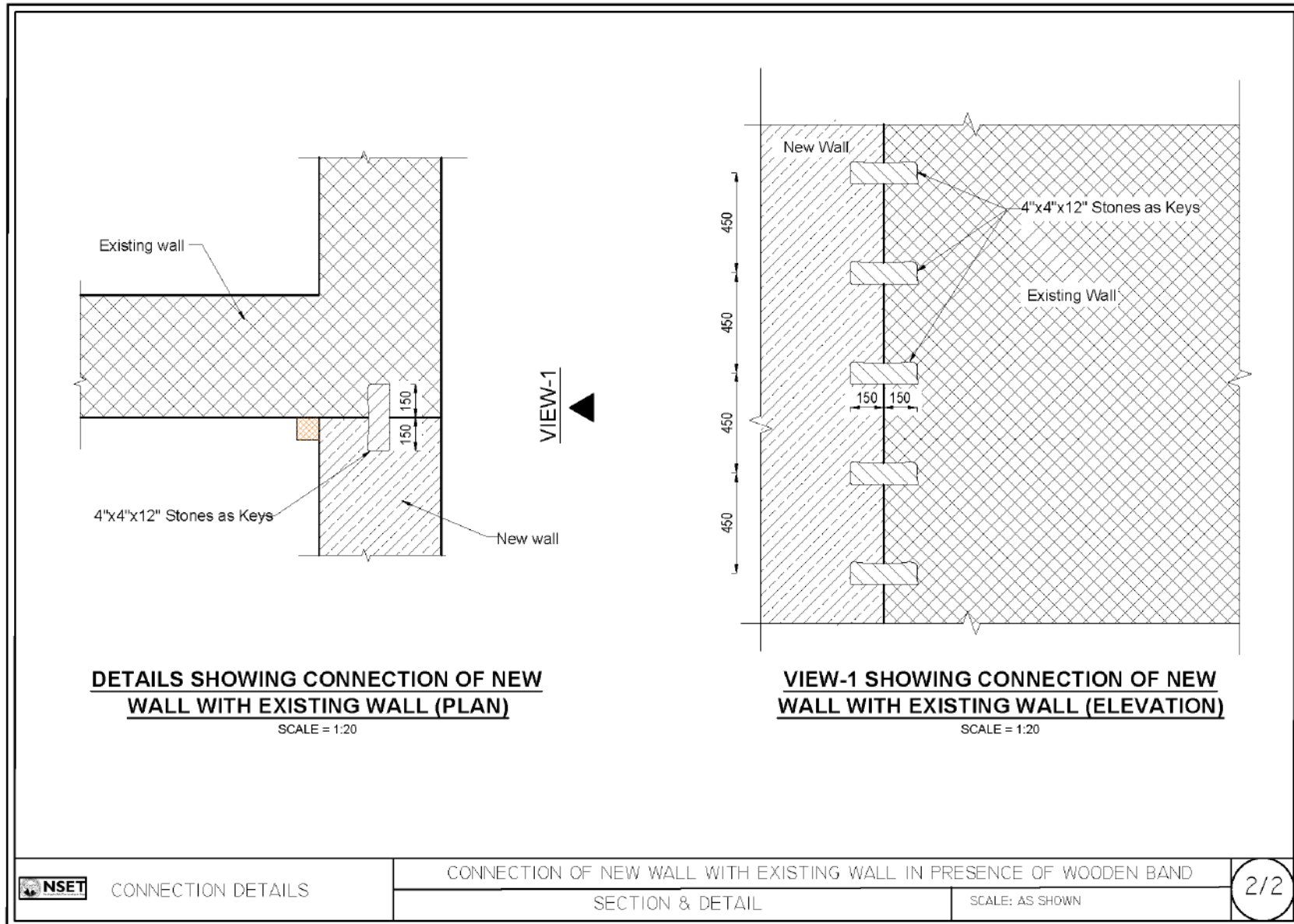

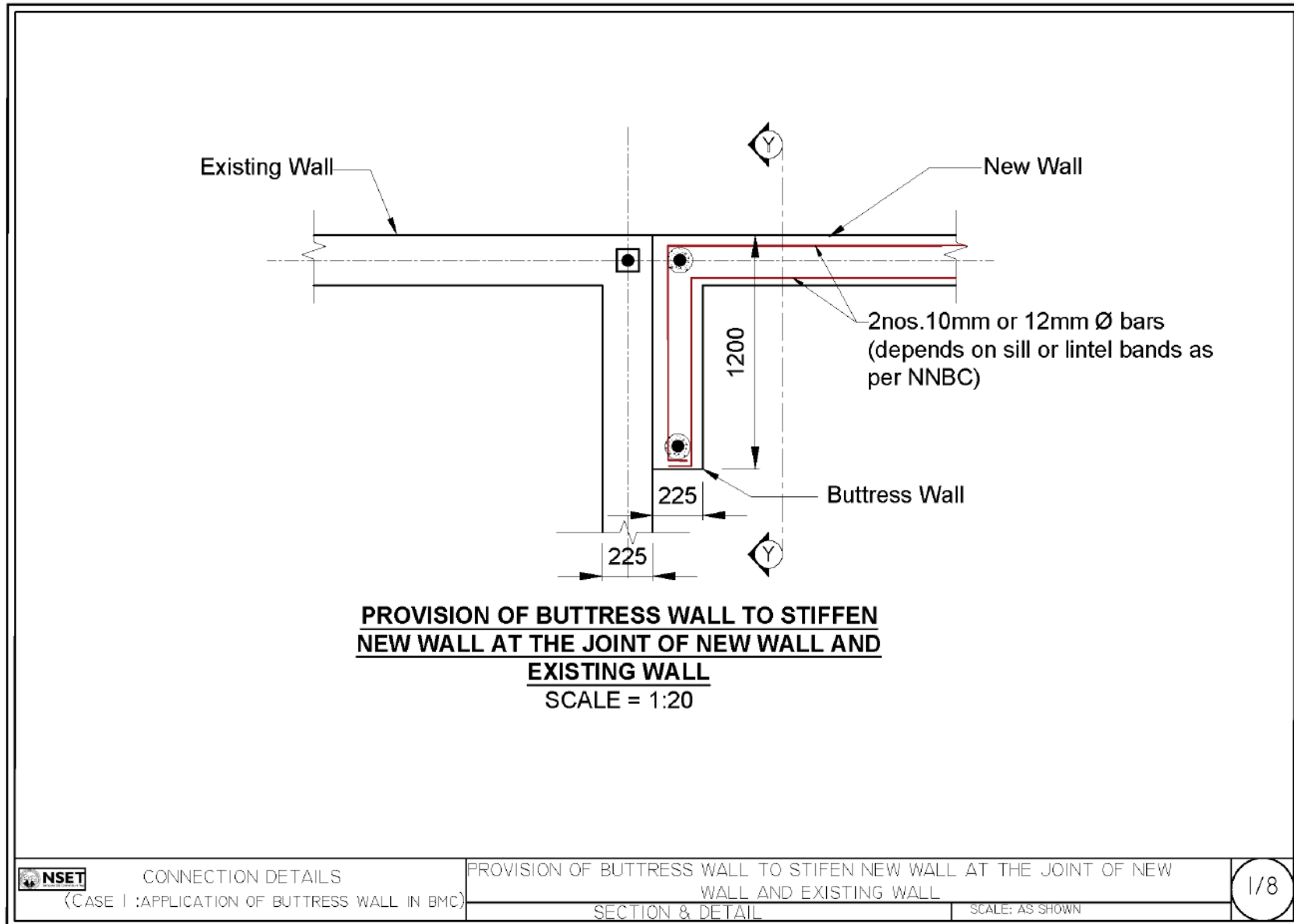

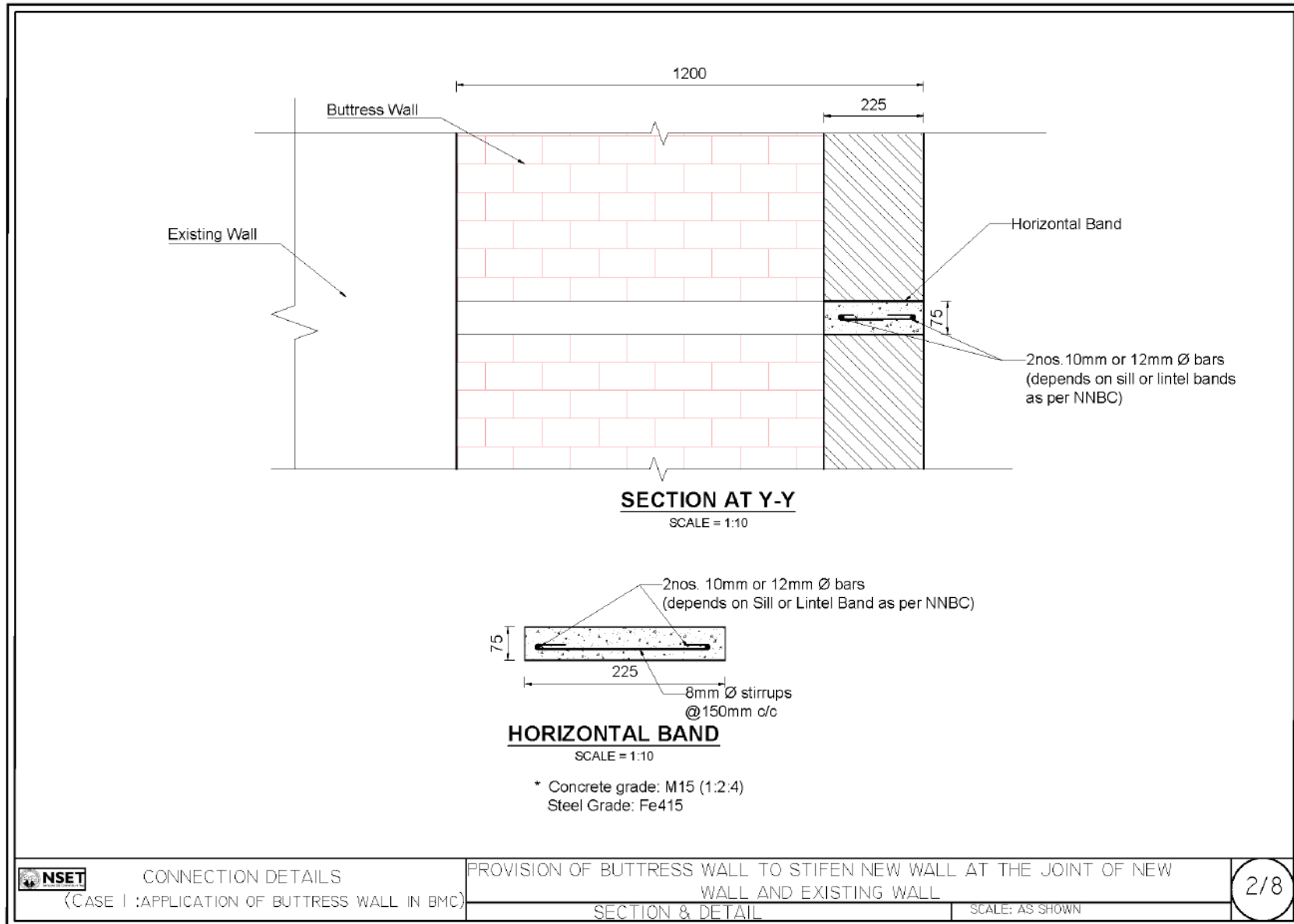

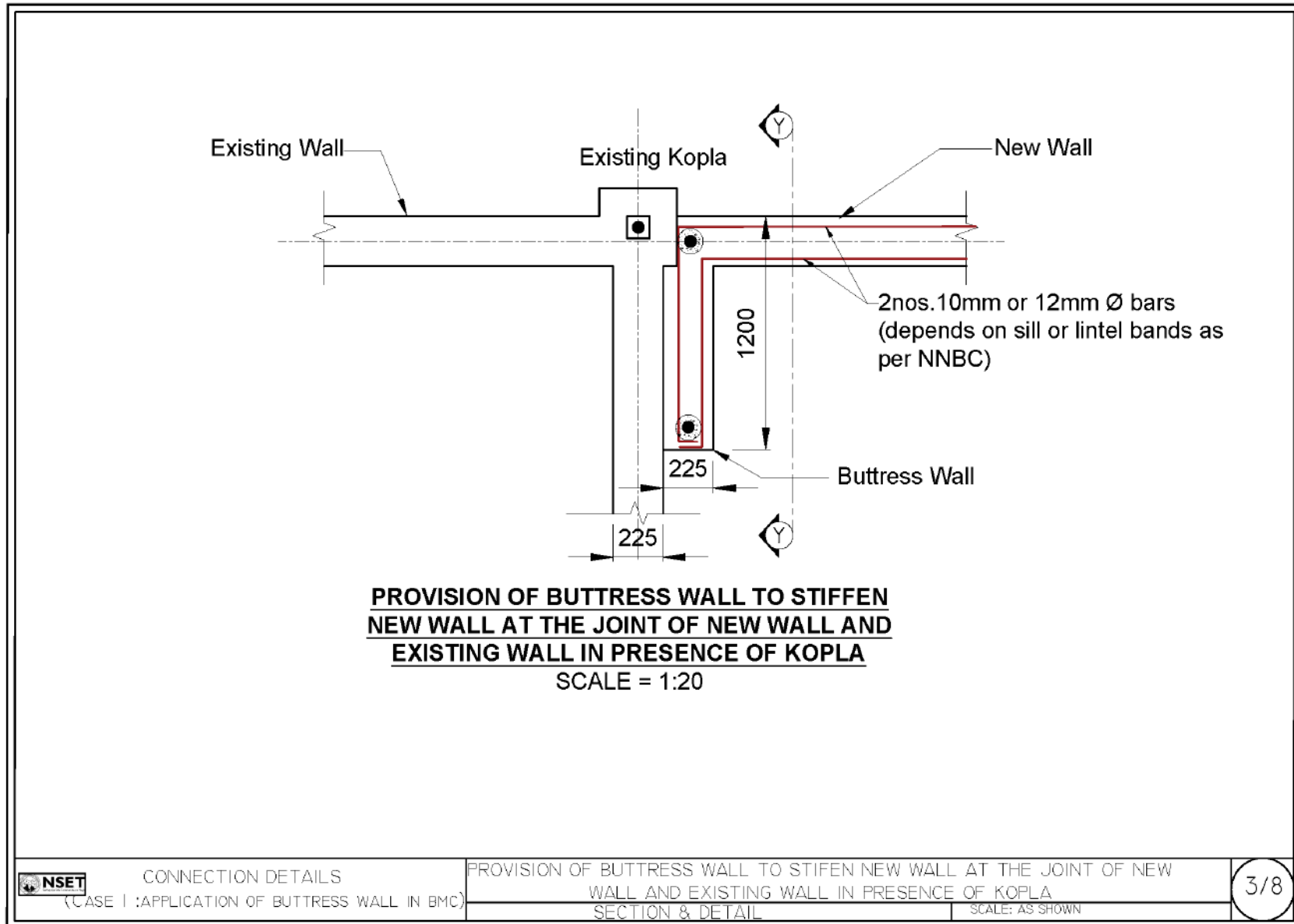

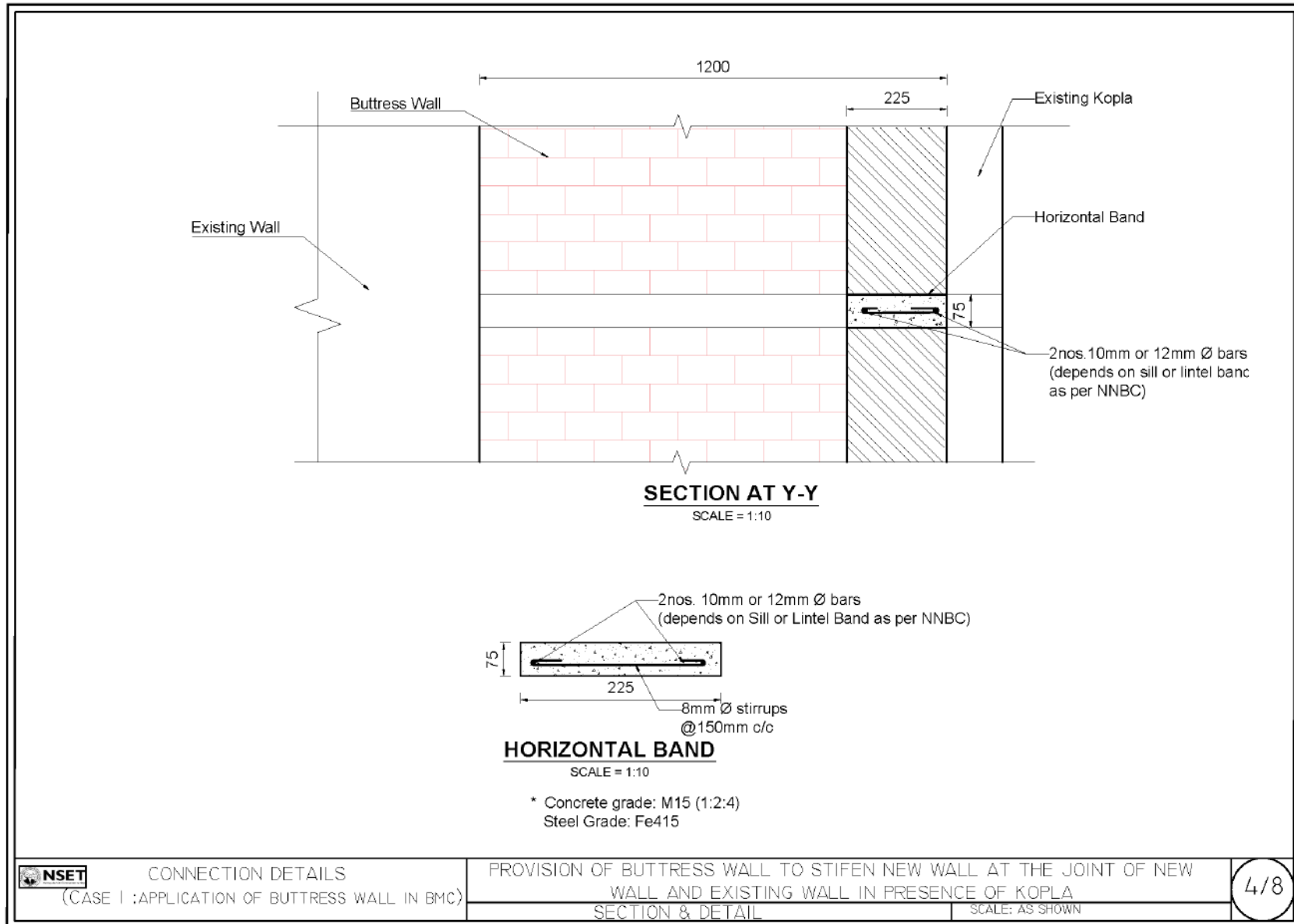

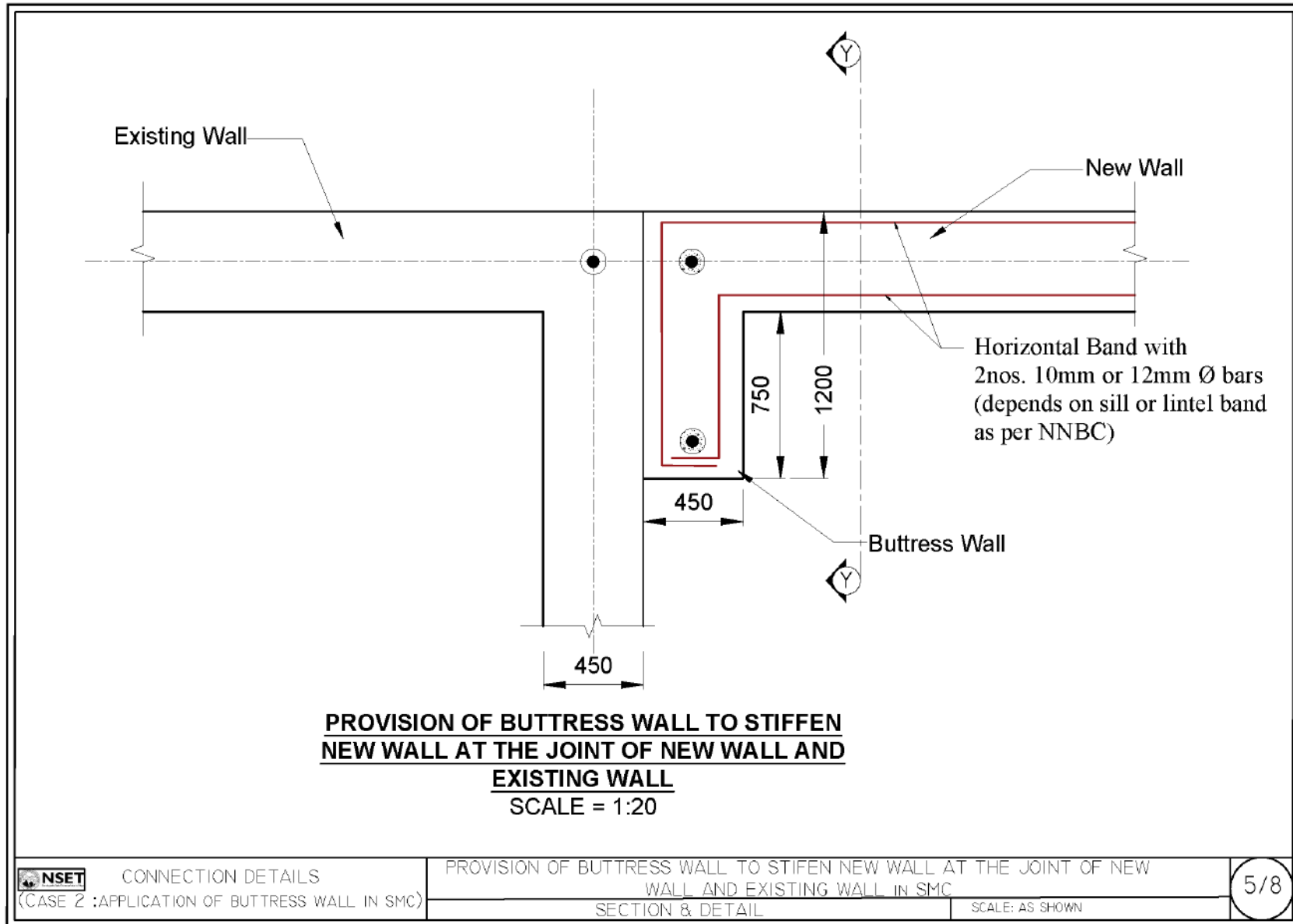



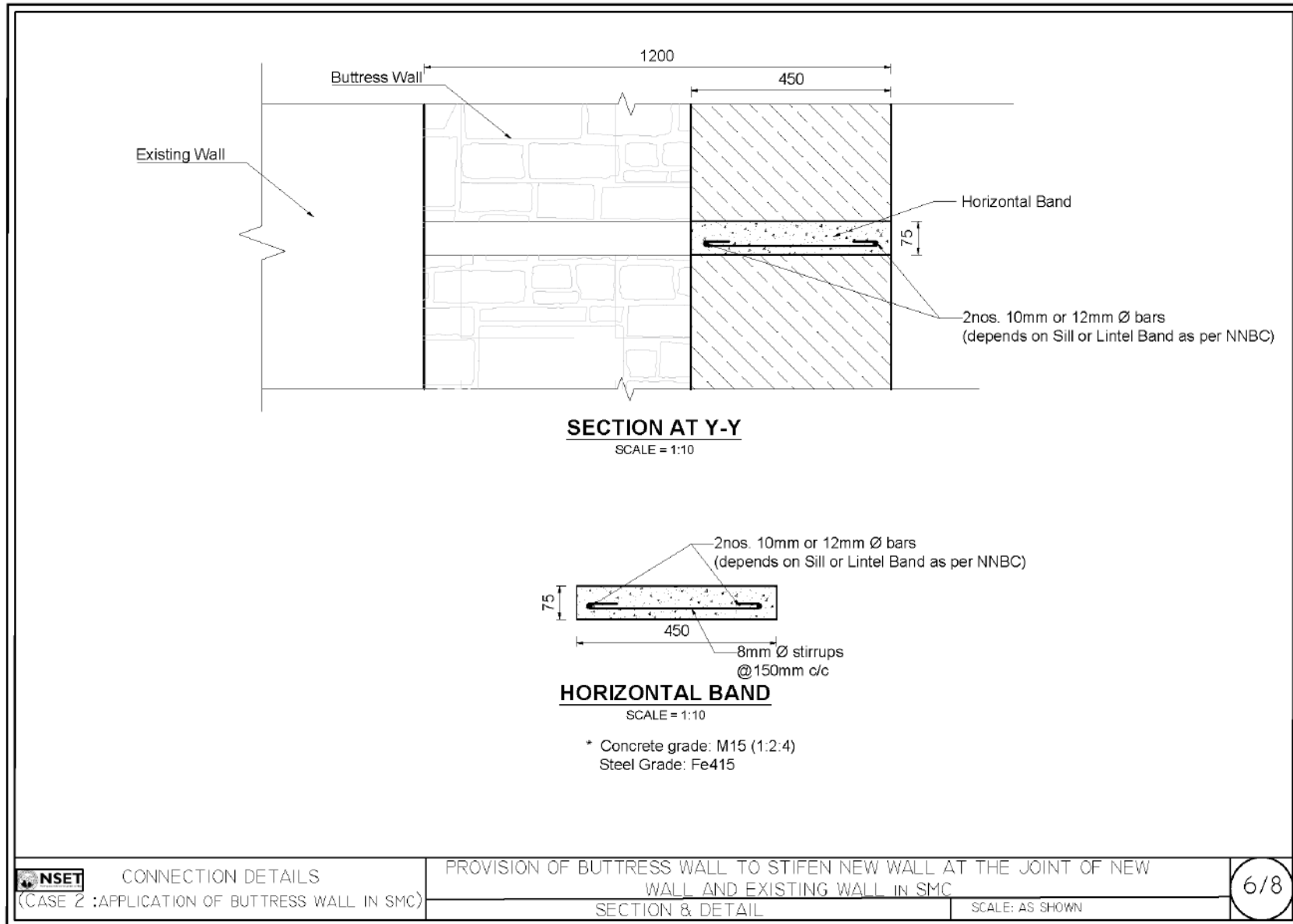

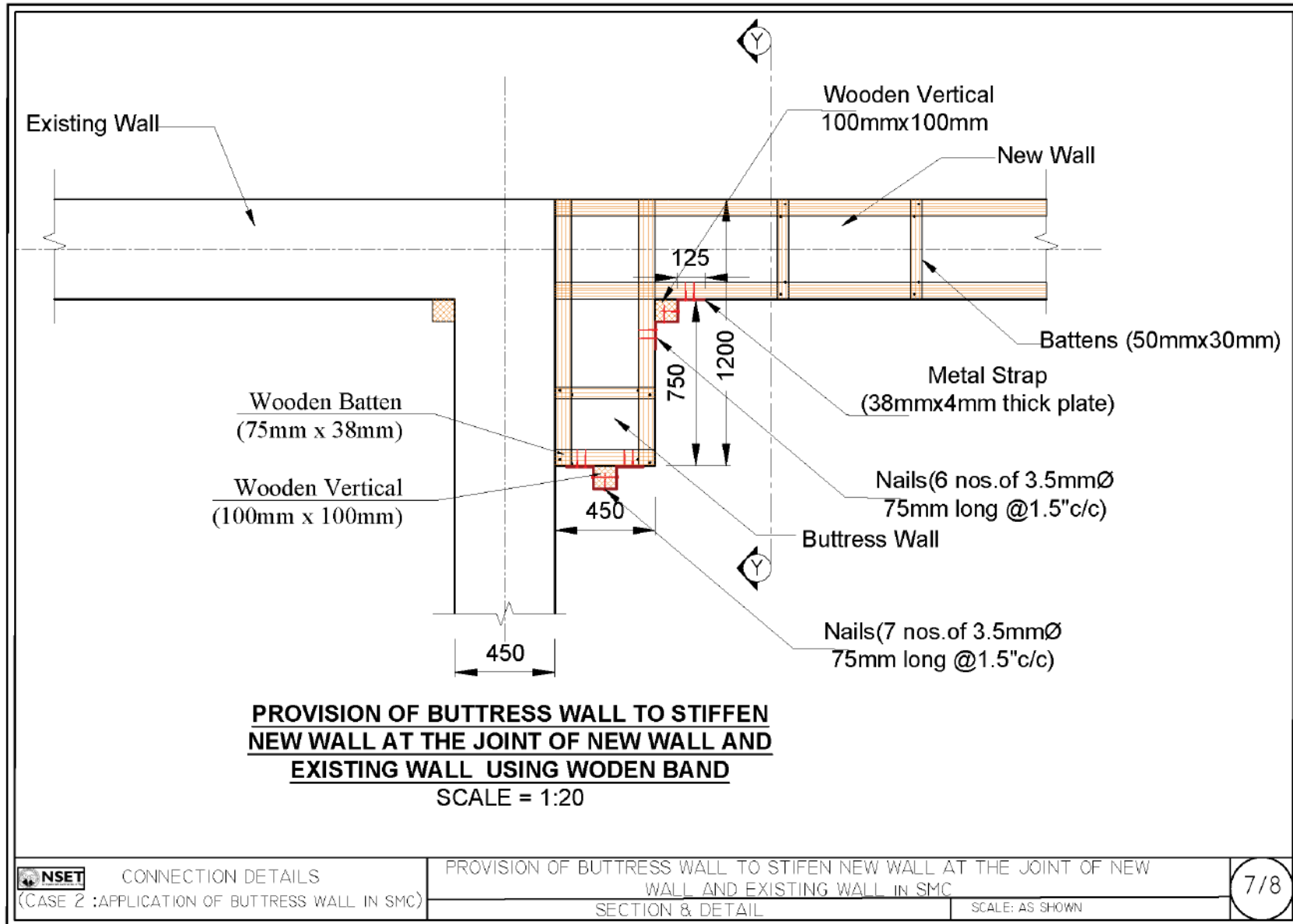

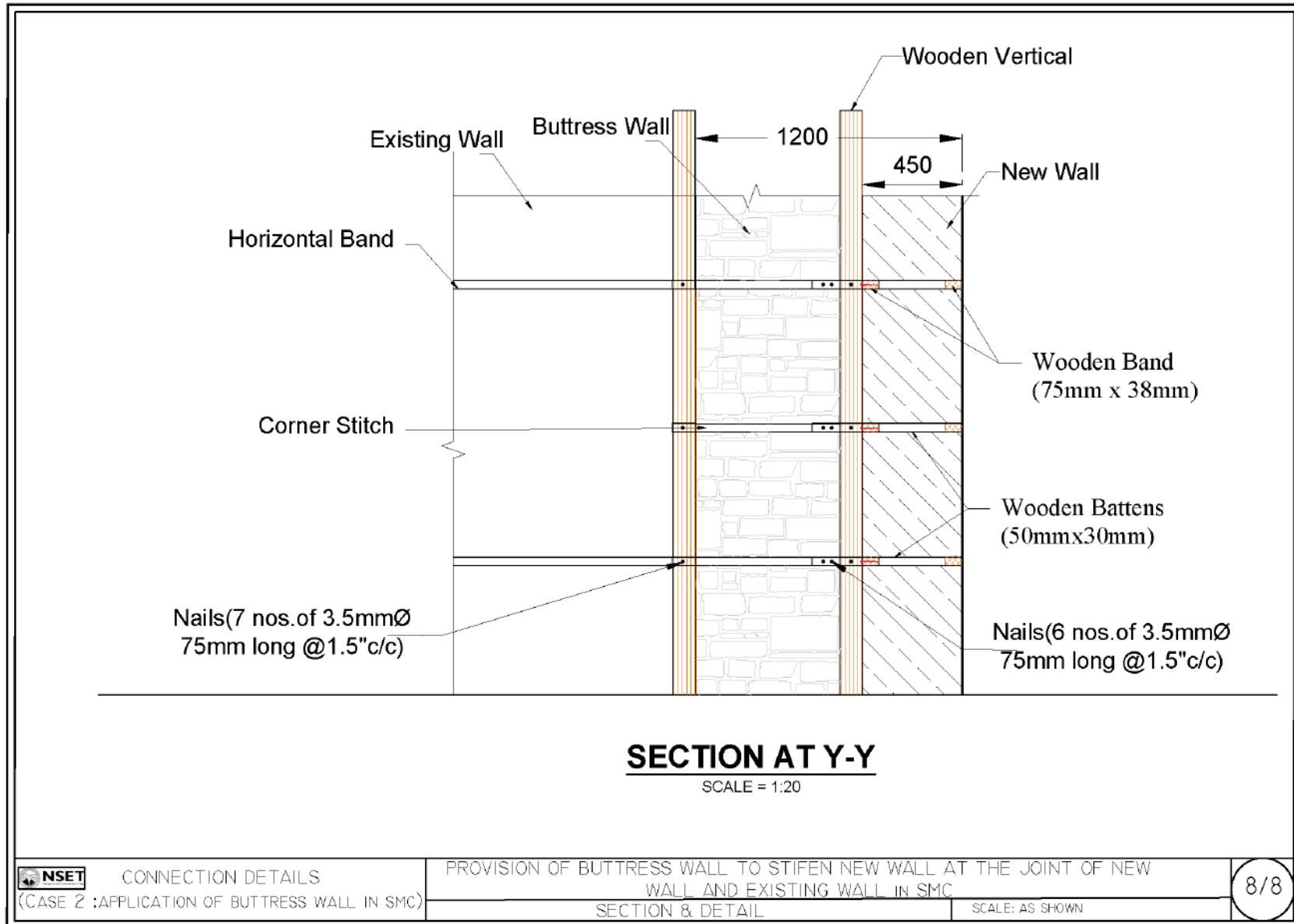

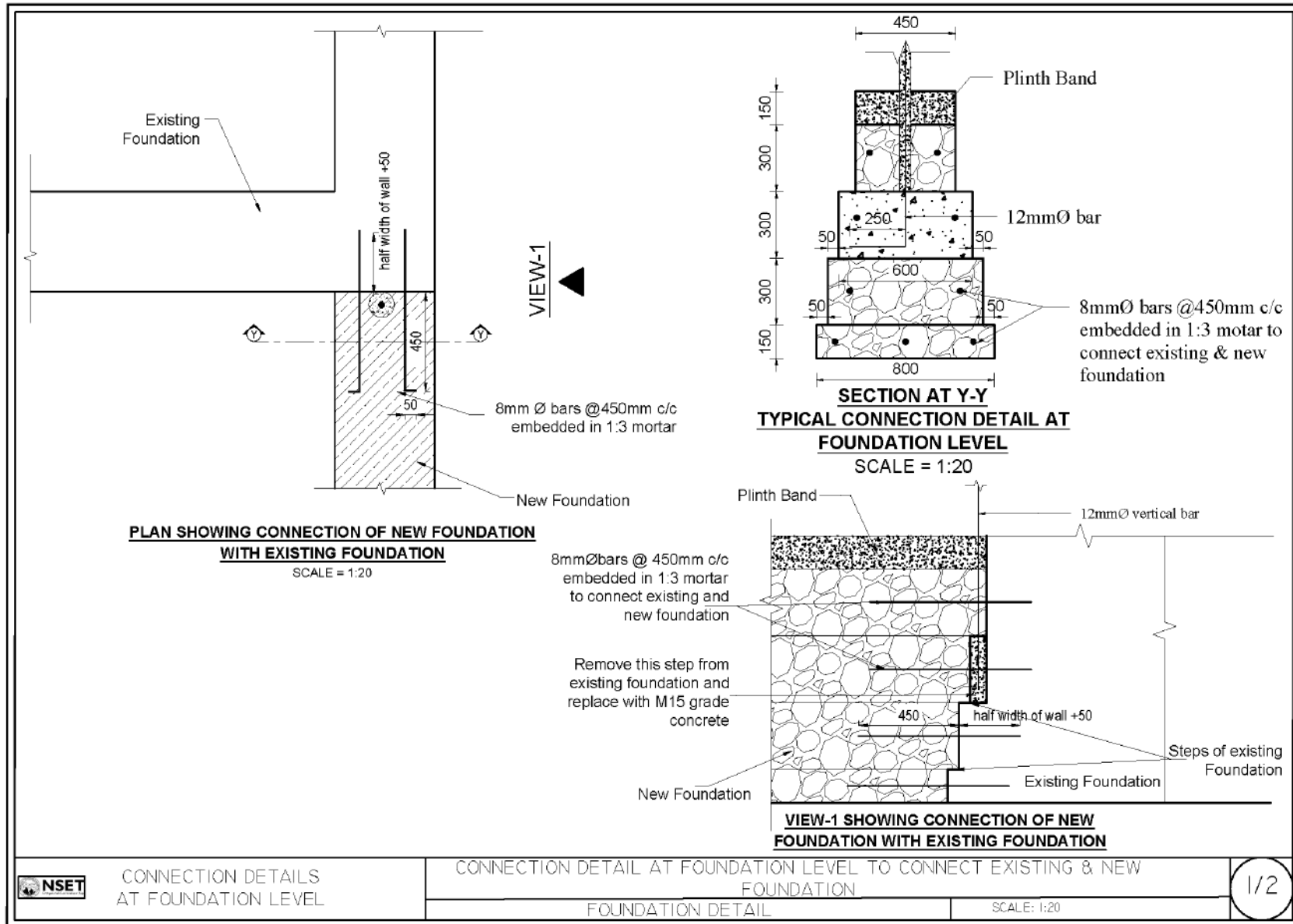

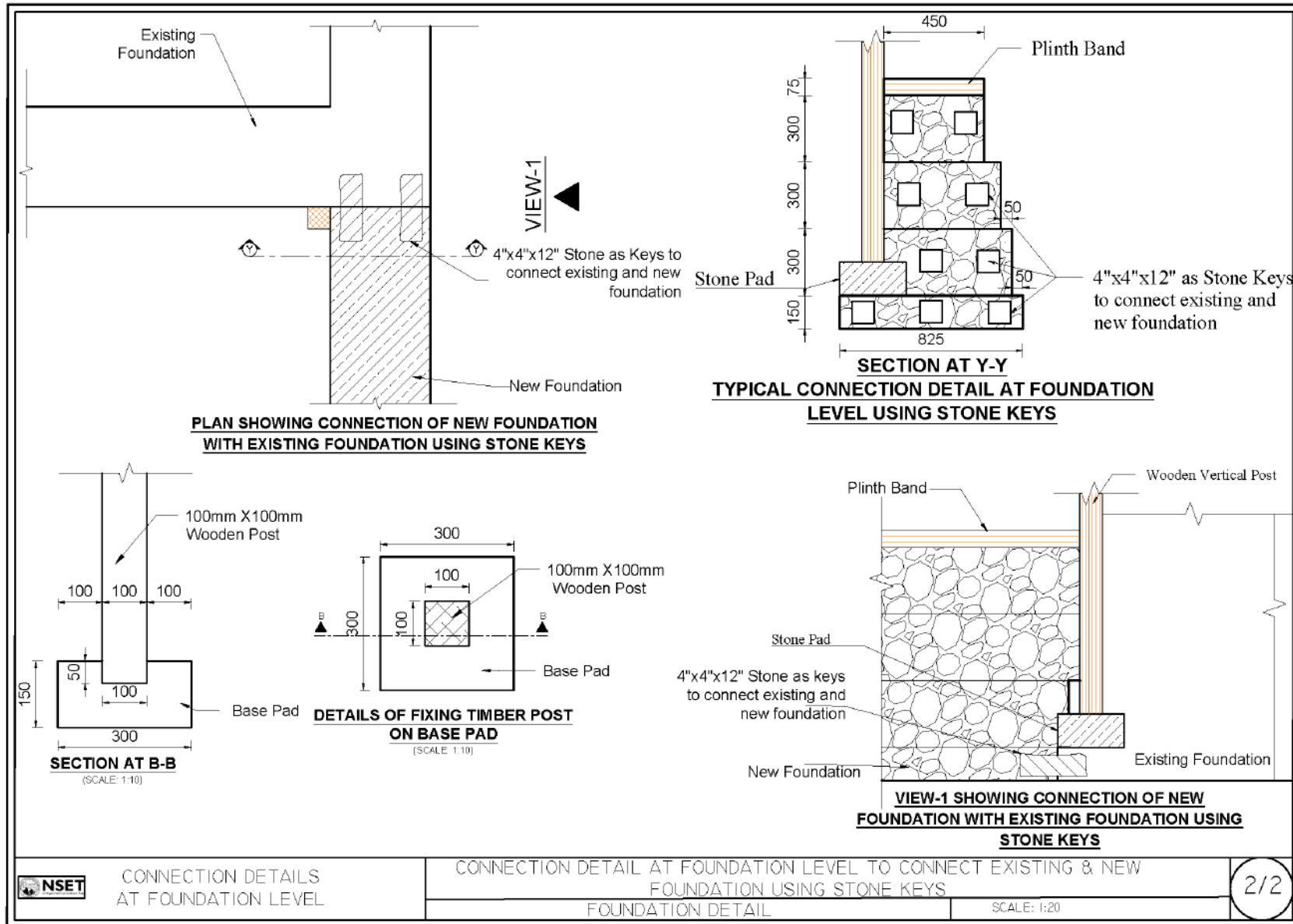

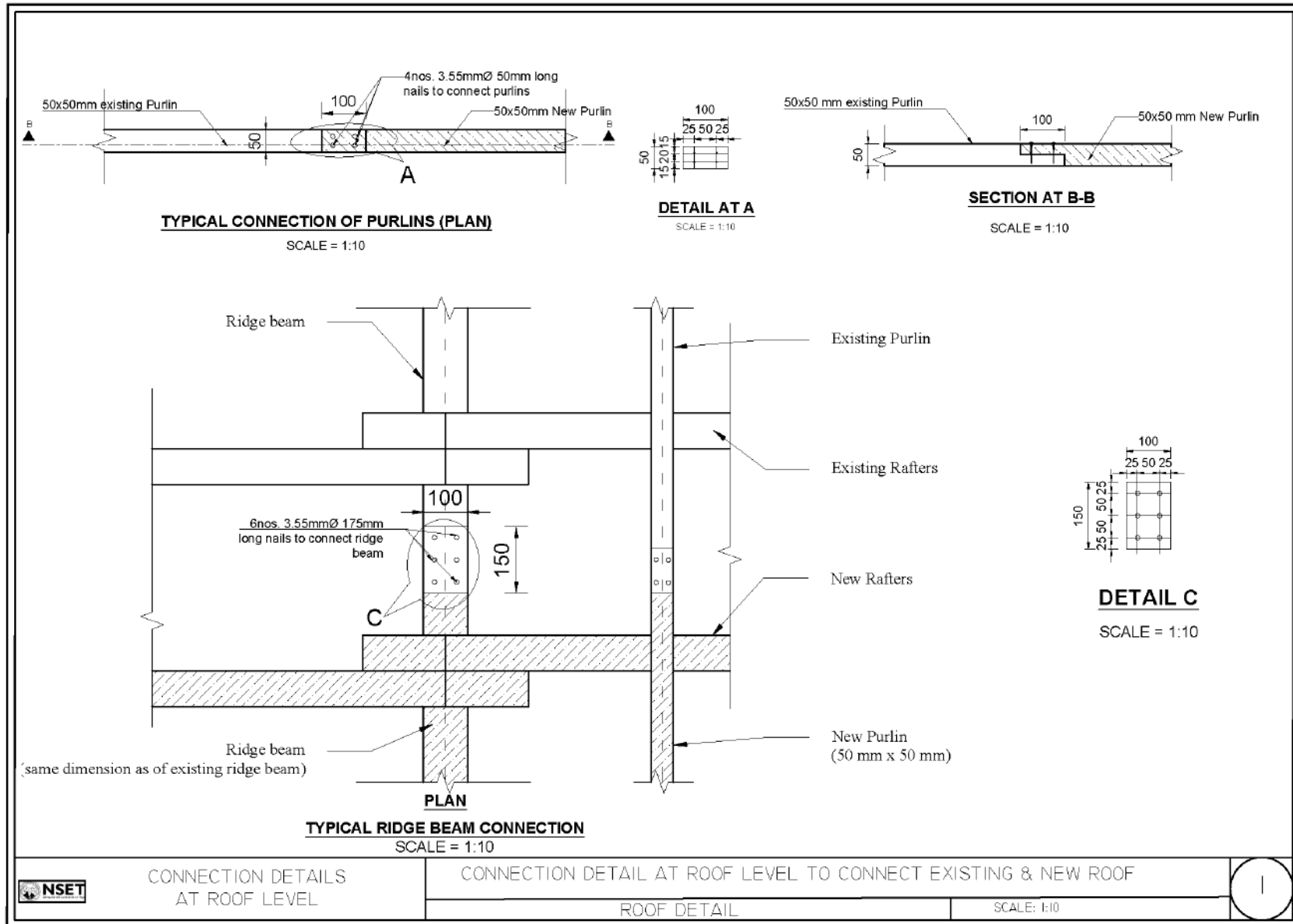

Supported by





**Government of Nepal**  
**National Reconstruction Authority (NRA)**

Singh Durbar, Kathmandu, Nepal  
Tel: (977-01) 4211482, 4211467, Fax: 4211473  
Email: [info@nra.gov.np](mailto:info@nra.gov.np), Web: [nra.gov.np](http://nra.gov.np)